

AUTOMOBILE ENGINEERING AND HYBRID VEHICLES

INTRODUCTION

What is Automobile

A self-propelled passenger vehicle that usually has four wheels and an internal-combustion engine, used for land transport. Also called *motorcar*.

An automobile (or automotive) is a vehicle that is capable of propelling itself. Since seventeenth century, several attempts have been made to design and construct a practically operative automobile.

Today, automobiles play an unimaginable role in the social, economic and industrial growth of any country. After the introduction of internal combustion engines, the Automobile industry has seen a tremendous growth.

Classification of automobile:

Automobiles can be classified into several types based on several criteria. A brief classification of automobiles is listed below:

Based on purpose:

1. **Passenger vehicles** – These automobiles carry passengers – e.g.: Buses, Passenger trains, cars
2. **Goods vehicles** – These vehicles are used for transportation of goods from one place to another. e.g.: Goods lorry, goods carrier

Based on capacity:

1. **Heavy Motor Vehicle (HMV)** – Large and bulky motor vehicles – e.g.: Large trucks, buses
2. **Light Motor Vehicle (LMV)** – Small motor vehicles – e.g.: Cars, Jeeps
3. **Medium Vehicle** – Relatively medium sized vehicles – e.g.: Small trucks, mini buses

Based on fuel source:

1. **Petrol engine vehicles** – Automobiles powered by petrol engine – e.g.: scooters, cars, mopeds, motorcycles
2. **Diesel engine vehicles** – Automotives powered by diesel engine – e.g.: Trucks, Buses

3. **Gas vehicles** – Vehicles that use gas turbine as power source – e.g.: Turbine powered cars
4. **Solar vehicles** – Vehicles significantly powered by solar power – e.g.: Solar powered cars
5. **Hydrogen vehicles** – Vehicles that have hydrogen as a power source – e.g.: Honda FCX Clarity
6. **Electric vehicles** – Automobiles that use electricity as a power source – e.g.: Electric cars, electric buses
7. **Steam Engine Vehicles** – Automotives powered by steam engine – e.g.: Steamboat, steam locomotive, steam wagon
8. **Hybrid Vehicles** – Vehicles that use two or more distinct power sources – e.g.: Hybrid buses, hybrid cars like Toyota Prius, Honda Insight
9. **Hybrid Electric Vehicle (HEV)** – Automobile that uses both Internal Combustion Engine and Electric Power Source to propel itself – e.g.: Jaguar C-X75

Based on type of transmission:

1. **Automatic transmission vehicles** – Automobiles that are capable of changing gear ratios automatically as they move – e.g.: Automatic Transmission Cars
2. **Conventional transmission vehicles** – Automotives whose gear ratios have to be changed manually
3. **Semi-automatic transmission vehicles** – Vehicles that facilitate manual gear changing with clutch pedal

Based on number of wheels:

1. **Two wheeler** – Automobiles having two wheels – e.g.: Scooters, motorcycles
2. **Three wheeler** – Automotive having three wheels – e.g.: Tricycles, Auto rickshaws, Tempos
3. **Four wheeler** – Vehicle having four wheels – e.g.: Car, Jeep
4. **Six wheeler** – Automobile having six wheels used for heavy transportation – e.g.: Large trucks, large buses

Based on the side of drive:

1. **Left hand drive automobile** – Vehicle in which steering wheel is fitted on the left hand side – e.g.: Automobiles found in USA, Russia
2. **Right hand drive automobile** - Vehicle in which steering wheel is fitted on the right hand side – e.g.: Automobiles found in India, Australia

Integrated Frame and Body

The integrated frame and body type of construction (image 3) also referred to as unitized construction, combines the frame and body into a single, one-piece structure.

This is done by welding the components together, by forming or casting the entire structure as one piece, or by a combination of these techniques. Simply by welding a body to a conventional

frame, however, does not constitute an integral frame and body construction. In a truly integrated structure, the entire frame-body unit is treated as a load-carrying member that reacts to all

Integrated-type bodies for wheeled vehicles are fabricated by welding preformed metal panels together. The panels are preformed in various load-bearing shapes that are located and oriented so as to result in a uniformly stressed structure. Some portions of the integrated structure resemble frame like components, while others resemble body like panels. This is not surprising, because the structure must perform the functions of both of these elements.

An integrated frame and body type construction allows and increases in the amount of noise transmitted into the passenger compartment of the vehicle. However, this disadvantage is negated by the following advantages:

Substantial weight reduction, which is possible when using a well-designed unitized body. Lower cargo floor and vehicle height. Protection from mud and water required for driveline components on amphibious vehicles. Reduction in the amount of vibration present in the vehicle structure

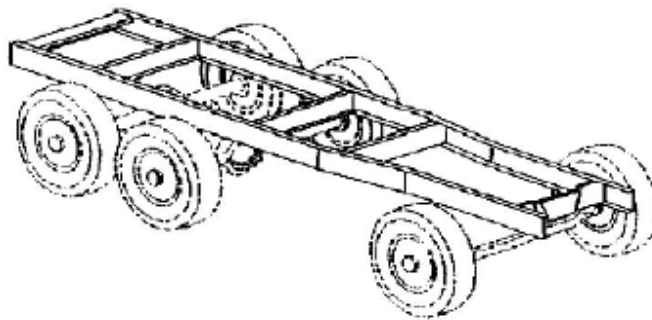

Image 3 - Integrated Frame and Body

Ladder Frame (Truck Frame)

The truck frame (image 4) allows different types of truck beds or enclosures to be attached to the frame. For larger trucks, the frames are simple, rugged, and of channel iron construction. The side rails are parallel to each other at standardized widths to permit the mounting of stock transmissions, transfer cases, rear axles, and other similar components. Trucks that are to be used as prime movers have an additional reinforcement of the side rails and rear cross members to compensate for the added towing stresses.

There are almost as many different types of four-wheel-drive systems as there are four-wheel-drive vehicles. It seems that every manufacturer has several different schemes for providing power to all of the wheels. The language used by the different carmakers can sometimes be a little confusing, so before we get started explaining how they work, let's clear up some terminology:

- **Four-wheel drive** - Usually, when carmakers say that a car has **four-wheel drive**, they are referring to a **part-time** system. For reasons we'll explore later in this article, these systems are meant only for use in low-traction conditions, such as off-road or on snow or ice.
- **All-wheel drive** - These systems are sometimes called **full-time four-wheel drive**. All-wheel-drive systems are designed to function on all types of surfaces, both on- and off-road, and most of them cannot be switched off.

Part-time and full-time four-wheel-drive systems can be evaluated using the same criteria. The best system will send exactly the right amount of torque to each wheel, which is the maximum torque that won't cause that tire to slip.

In this article, we'll explain the fundamentals of four-wheel drive, starting with some background on traction, and look at the components that make up a four-wheel-drive system. Then we'll take a look at a couple of different systems, including the one found on the Hummer, manufactured for GM by AM General.

We need to know a little about torque, traction and wheel slip before we can understand the different four-wheel-drive systems found on cars.

POWER

POWER is the measure of how much work can be done in a specified **time**. In the example on the [Work and Energy](#) page, the guy pushing the car did 16,500 foot-pounds of work. If he did that work in two minutes, he would have produced 8250 foot-pounds per minute of power (165 feet x 100 pounds ÷ 2 minutes). If you are unclear about work and energy, it would be a benefit to review those concepts [here](#).

In the same way that one *ton* is a large amount of weight (by definition, 2000 pounds), one *horsepower* is a large amount of power. The definition of one horsepower is 33,000 foot-pounds per minute. The power which the guy produced by pushing his car across the lot (8250 foot-pounds-per-minute) equals ¼ horsepower (8,250 ÷ 33,000).

OK, all that's fine, but how does pushing a car across a parking lot relate to rotating machinery? Consider the following change to the *handle-and-crank-arm* sketch above. The handle is still 12" from the center of the shaft, but now, instead of being fixed to the wall, the shaft now goes through the wall, supported by frictionless bearings, and is attached to a generator behind the wall.

Suppose, as illustrated in **Figure 2**, that a constant force of 100 lbs. is somehow applied to the handle so that the force is always perpendicular to both the handle and the crank-arm as the crank turns. In other words, the "arrow" rotates with the handle and remains in the same position relative to the crank and handle, as shown in the sequence below. (That is called a "tangential force").

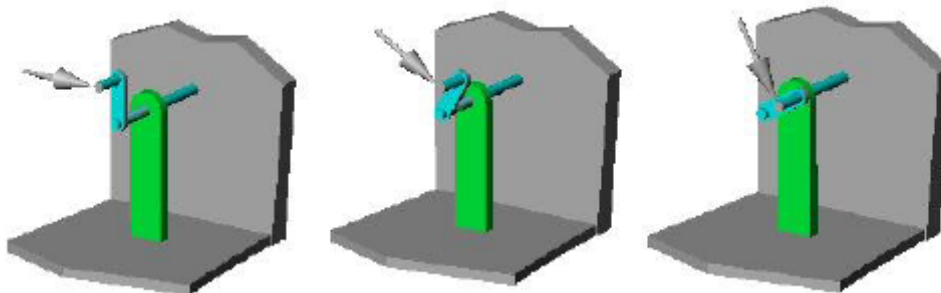

Figure 2

If that constant 100 lb. tangential force applied to the 12" handle (100 lb-ft of torque) causes the shaft to rotate at 2000 RPM, then the power the shaft is transmitting to the generator behind the wall is **38 HP**, calculated as follows:

100 lb-ft of torque (100 lb. x 1 foot) times 2000 RPM divided by 5252 is 38 HP.

The following examples illustrate several different values of **TORQUE** which produce **300 HP**.

Example 1: How much **TORQUE** is required to produce 300 HP at 2700 RPM?

since $\text{HP} = \text{TORQUE} \times \text{RPM} \div 5252$
then by rearranging the equation:
 $\text{TORQUE} = \text{HP} \times 5252 \div \text{RPM}$

Answer: TORQUE = 300 x 5252 ÷ 2700 = 584 lb-ft.

Example 2: How much TORQUE is required to produce 300 HP at 4600 RPM?

Answer: TORQUE = 300 x 5252 ÷ 4600 = 343 lb-ft.

Example 3: How much TORQUE is required to produce 300 HP at 8000 RPM?

Answer: TORQUE = 300 x 5252 ÷ 8000 = 197 lb-ft.

Example 4: How much TORQUE does the 41,000 RPM turbine section of a 300 HP gas turbine engine produce?

Answer: TORQUE = 300 x 5252 ÷ 41,000 = 38.4 lb-ft.

Example 5: The output shaft of the gearbox of the engine in Example 4 above turns at 1591 RPM. How much TORQUE is available on that shaft?

*Answer: TORQUE = 300 x 5252 ÷ 1591 = 991 lb-ft.
(ignoring losses in the gearbox, of course).*

The point to be taken from those numbers is that a given amount of horsepower can be made from an infinite number of combinations of torque and RPM.

Think of it another way: In cars of equal weight, a 2-liter twin-cam engine that makes 300 HP at 8000 RPM (197 lb-ft) and 400 HP at 10,000 RPM (210 lb-ft) will get you out of a corner just as well as a 5-liter engine that makes 300 HP at 4000 RPM (394 lb-ft) and 400 HP at 5000 RPM (420 lb-ft). In fact, in cars of equal weight, the smaller engine will probably race BETTER because it's much lighter, therefore puts less weight on the front end. AND, in reality, the car with the lighter 2-liter engine will likely weigh less than the big V8-powered car, so will be a better race car for several reasons.

Measuring Power

a *dynamometer* determines the power an engine produces by applying a load to the engine output shaft by means of a water brake, a generator, an eddy-current absorber, or any other controllable device capable of absorbing power. the dynamometer control system causes the absorber to exactly match the amount of torque the engine is producing at that instant, then *measures* that torque and the rpm of the engine shaft, and from those two measurements, it calculates observed power. then it applies various factors (air temperature, barometric pressure, relative humidity) in order to *correct* the observed power to the value it *would have been if it had been measured at standard atmospheric conditions*, called **corrected power**.

Power to Drive a Pump

In the course of working with lots of different engine projects, we often hear the suggestion that engine power can be increased by the use of a "better" oil pump. Implicit in that suggestion is the

belief that a "better" oil pump has higher pumping efficiency, and can, therefore, deliver the required flow at the required pressure while consuming less power from the crankshaft to do so. While that is technically true, the magnitude of the improvement number is surprisingly small.

How much power does it take to drive a pump delivering a known flow at a known pressure? we have already shown that power is work per unit time, and we will stick with good old American units for the time being (foot-pounds per minute and inch-pounds per minute). and we know that flow times pressure equals power, as shown by:

Flow (cubic inches / minute) multiplied by pressure (pounds / square inch) = power (inch-pounds / minute)

From there it is simply a matter of multiplying by the appropriate constants to produce an equation which calculates hp from pressure times flow. Since flow is more frequently given in gallons per minute, and since it is well known that there are 231 cubic inches in a gallon, then:

Flow (GPM) x 231(cubic inches / gal) = Flow (cubic inches per minute).

Since, as explained above, 1 HP is 33,000 foot-pounds of work per minute, multiplying that number by 12 produces the number of inch-pounds of work per minute in one HP (396,000). Dividing 396,000 by 231 gives the units-conversion factor of 1714.3. Therefore, the simple equation is:

Pump HP = flow (GPM) x pressure (PSI) / 1714.

That equation represents the power consumed by a pump having 100% efficiency. When the equation is modified to include pump efficiency, it becomes:

Pump HP = (flow {GPM} x pressure {PSI}) / (1714 x efficiency)

Common gear-type pumps typically operate at between 75 and 80% efficiency. So suppose your all-aluminum V8 engine requires 10 GPM at 50 psi. The oil pump will have been sized to maintain some preferred level of oil pressure at idle when the engine and oil are hot, so the pump will have far more capacity than is required to maintain the 10 GPM at 50 psi at operating speed. (That's what the "relief" valve does: bypasses the excess flow capacity back to the inlet of the pump, which, as an added benefit, also dramatically reduces the prospect cavitations in the pump inlet line.)

So suppose your 75%-efficient pump is maintaining 50 psi at operating speed, and is providing the 10 GPM needed by the engine. It is actually pumping roughly 50 GPM (10 of which goes through the engine, and the remaining 40 goes through the relief valve) at 50 psi. The power to drive that pressure pump stage is:

HP = (50gpm x 50 psi) / (1714 x 0.75 efficiency) = 1.95 HP

Suppose you succumb to the hype and shuck out some really big bucks for an allegedly 90% efficient pump. That pump (at the same flow and pressure) will consume:

HP = (50gpm x 50 psi) / (1714 x 0.90 efficiency) = 1.62 HP.

Typically, the torque peak will occur at a substantially lower rpm than the power peak. The reason is that, in general, the torque curve does not drop off (%-wise) as rapidly as the rpm is increasing (%-wise). For a race engine, it is often beneficial (within the boundary conditions of the application) to operate the engine well beyond the power peak, in order to produce the maximum average power within a required rpm band.

However, for an engine which operates in a relatively narrow rpm band, such as an aircraft engine, it is generally a requirement that the engine produce maximum power at the maximum rpm. That requires the torque peak to be fairly close to the maximum rpm. For an aircraft engine, you typically design the torque curve to peak at the normal cruise setting and stay flat up to maximum rpm. That positioning of the torque curve would allow the engine to produce significantly more power if it could operate at a higher rpm, but the goal is to optimize the performance within the operating range.

an example of that concept is shown figure 3 below. The three dashed lines represent three different torque curves, each having exactly the same shape and torque values, but with the peak torque values located at different rpm values. The solid lines show the power produced by the torque curves of the same color.

COMPONENTS OF AN ENGINE

An engine comprises of a few hundred components : small and big, stationary and moving, metallic and non-metallic, casted and .forged and made by other processes. The components of an engine can be grouped under two categories.

1. Stationary or Structure forming components, and
2. Moving or Mechanism forming components

The stationary components constitute the structural parts and the moving components synthesize the mechanism parts of an engine. Important components among these are listed below.

Mechanism forming components

Piston

Piston rings

Gudgeon (or piston) pin Connecting rod

Crank

Crankshaft

Camshaft

Valves

Valves operating mechanism Timing gears

Chain and sprocket

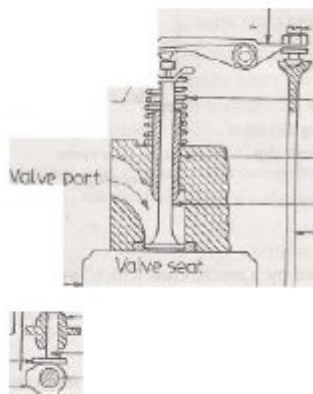

Valve operating mechanism for an overhead valve engine employing an under head camshaft.

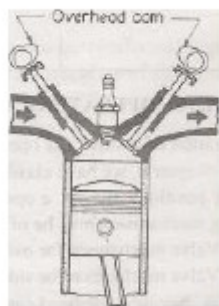

A double overhead cam (DOHC) operated inclined overhead valve mechanism

Belt and pulleys

Flywheel

Structural components

Cylinder block

Cylinder head

Gaskets

Cylinder liner

Crankcase

Manifolds: Inlet and Outlet Oil pan

Resonator

Muffler (silencer)

Vibration damper

Bearings

Fasteners

Turbocharger

VALVE OPERATING MECHANISMS

The operation of a valve (its opening and closing) is accomplished by a mechanism which involves several parts depending upon the valve position; the valve operating mechanisms may also differ in their arrangements. Hence, the valve operating mechanisms may be of the following types.

1. Valve mechanism for overhead valve engines.
2. Valve mechanism for side valve engines
 - (i) Having under head camshaft /
 - (ii) having overhead camshaft.

Valve Mechanism for Overhead Valve, Under head Camshaft Engine: The engine valve

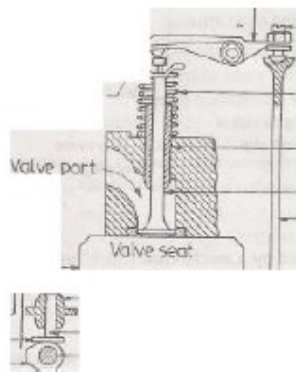

Valve operating mechanism for an overhead valve engine employing an under head camshaft.



A double overhead cam (DOHC) operated inclined overhead valve mechanism

Valve face

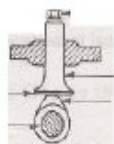
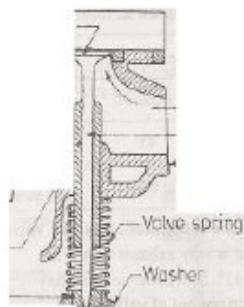

Valve operating mechanism for a side valve engine.

Valve Mechanism for Side Valve Engines: Such arrangement is employed on L-head engines. The diagram is self-explanatory, and needs no further explanation:- The advantage and disadvantages of side valve mechanism can be enumerated as below.

1. Low engine height is possible as there are no parts above the cylinder head.
2. Lubrication is easier for the valve mechanism.
3. Working is quieter as there is no rocker arm assembly.
4. Mechanism is less complicated than that in overhead valve engines.
5. Volumetric efficiency and compression ratio are poor.
6. Shape of the combustion chamber is complicated.
7. Space for inlet valve is restricted.

Resistance to motion

This is the resistance a vehicle faces while attempting to move from a stall condition or while accelerating. This resistance must be overcome by the power plant of the engine in order to sustain motion. When the power produced is smaller than the resistance to motion, the vehicle will gradually slow down. We must have experienced the slowing down of bicycles if we stop pedaling. The bicycle also slows down if we go uphill or if wind blows from front. A poorly inflated tire also causes the vehicle to groan more and slow down. These are the resistances that force the vehicle to slow down under their effect.

Broadly the resistances can be categorized into the following categories:

- Aerodynamic drag
- Gradient resistance
- Rolling resistance
- Inertia

All the above produce a restraining force working against the tractive force. The tractive force must be greater than or equal to the resistive forces in order to maintain a sustainable motion. We can balance them as

$$F = F_{req} = F_A + F_G + F_R + F_I$$

Where

F_A = Force due to air resistance

F_G = Force due to gradient of a slope

F_R = Force due to rolling resistance

F_I = Force due to moving or static inertia

The last one F_I comes into the picture only when the vehicle accelerates or decelerates, while the first three always offer a resistance even when the vehicle is moving at a constant speed.

Air resistance/ Aerodynamic drag:

When a body travels within a dense medium, the molecules of the medium collide with the moving object and thereby absorb some of the energy. This is felt as a resistance to the moving object. If the medium is denser, then the resistance is more. Also when the object moves at a faster speed, the resistance increases proportionately. Mathematically it can be expressed as:

$$F_A = \frac{1}{2} \times C_d \times P \times V^2$$

Where

C_d = Co-efficient of discharge

P = Pressure

V = Velocity of the vehicle

Gradient resistance:

When the vehicle travels uphill, a component of its weight works in a direction opposite to its motion. If some energy is not supplied to overcome this backward force, then the vehicle would slow down, stall and roll backwards. If the vehicle is trading uphill at a slope of θ , then the weight of the vehicle, W has two components: one perpendicular to the road surface (with a value $W \cdot \cos \theta$) and the other along the road surface (with a value $W \cdot \sin \theta$). The component along the road surface is the one that tries to restrict the motion.

The gradient resistance is given by: $F_G = W \cdot \sin \theta$

Rolling resistance

When a vehicle rolls, it rolls with its tires in contact with the road surface. The relative motion of two hard surfaces produces a friction. Further, neither the road, nor the tires are perfectly rigid. Hence, both flex under the load slightly. As there is a gradual deformation at the contact between the road and the tire, greatest at the bottom most point and least at the entry and exit points, the slip of the tire w.r.t. the road produces another type of loss of energy which results in a resistance.

Rolling resistance is composed of the following components:

- Tire Rolling resistance: $F_{R,T}$
- Road rolling resistance: $F_{R,Tr}$
- Resistance due to tire slip angle: $F_{R,c}$
- Resistance due to bearing friction and residual braking: $F_{R,fr}$

Hence the rolling resistance offered may be written as:

$$F_R = F_{R,T} + F_{R,Tr} + F_{R,c} + F_{R,fr}$$

The tire rolling resistance $F_{R,T}$ is a result of the resistance due to flexure of the tire, air resistance on the tire and friction of tire with the road. These three can be summed up and written as:

$$F_{R,T} = F_{R,T,flex} + F_{R,T,A} + F_{R,T,fr}$$

In a simplified manner the total rolling resistance can be related to the vertical load on the wheels and can be written as:

$$\text{Co-efficient of rolling friction, } k_R = \frac{F_R}{F_{Z,w}}$$

FACTORS THAT AFFECT THE ROLLING RESISTANCE OF A VEHICLE

- **Material** - different fillers and polymers in tire composition can improve traction while reducing hysteresis. The replacement of some carbon black with higher-priced silica-silane is one common way of reducing rolling resistance.
- **Dimensions** - rolling resistance in tires is related to the flex of sidewalls and the contact area of the tire. For example, at the same pressure wider bicycle tires have less flex in sidewalls and thus lower rolling resistance (although higher air resistance).
- **Extent of inflation** - Lower pressure in tires results in more flexing of sidewalls and higher rolling resistance. This energy conversion in the sidewalls increases resistance and can also lead to overheating and may have played a part in the infamous Ford Explorer rollover accidents.
- **Over inflating tires** (such a bicycle tires) may not lower the overall rolling resistance as the tire may skip and hop over the road surface. Traction is sacrificed, and overall rolling friction may not be reduced as the wheel rotational speed changes and slippage increases.
- **casing** will benefit the fuel economy through many casing lives (i.e. retreading), while a tire with a "fuel saving" tread design will only benefit until the tread wears down.
- In tires, tread thickness has much to do with rolling resistance. The thicker the tread, the higher the rolling resistance. Thus, the "fastest" bicycle tires have very little tread and heavy duty trucks get the best fuel economy as the tire tread wears out.
- **Hard steel rails** last longer but also have lower static friction (traction) than rubber tires. They may also suffer fatigue cracking because the cracked area is not worn away by the passing trains.

Smaller wheels, all else being equal, have higher rolling resistance than larger wheels. In some laboratory tests, smaller wheels appeared to have similar or lower losses than large wheels, but these tests were done rolling the wheels against a small-diameter drum, which would theoretically remove the advantage of large-diameter wheels, thus making the tests irrelevant for resolving this issue. Virtually all world speed records have been set on relatively narrow wheels, probably because of their aerodynamic advantage at high speed, which is much less important at normal speeds.

MODULE-II

CLUTCH

CLUTCH

Clutch is a machine member used to connect the driving shaft to a driven shaft, so that the driven shaft may be started or stopped at will, without stopping the driving shaft. A clutch thus provides an interruptible connection between two rotating shafts. Clutches allow a high inertia load to be started with a small power.

Clutches are used whenever the ability to limit the transmission of power or motion needs to be controlled either in amount or over time (e.g. electric screwdrivers limit how much torque is transmitted through use of a clutch; clutches control whether automobiles transmit engine power to the wheels).

In the simplest application clutches are employed in devices which have two rotating shafts. In these devices one shaft is typically attached to a motor or other power unit (the driving member) while the other shaft (the driven member) provides output power for work to be done. In a drill for instance, one shaft is driven by a motor and the other drives a drill chuck. The clutch connects the two shafts so that they may be locked together and spin at the same speed (engaged), locked together but spinning at different speeds (slipping), or unlocked and spinning at different speeds (disengaged).

A popularly known application of clutch is in automotive vehicles where it is used to connect the engine and the gear box. Here the clutch enables to crank and start the engine disengaging the transmission. Disengage the transmission and change the gear to alter the torque on the wheels. Clutches are also used extensively in production machinery of all types.

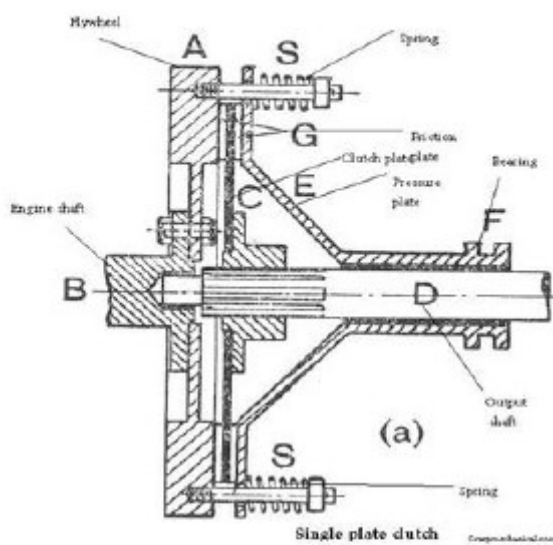

Single plate clutch

- When drivers wants to shift the gear or to stop the vehicle. He depress clutch pedal so that the fork pushed the forward and pushes the clutch bearing and finger.
- The finger are pivoted so that they pulls the pressure plate back hence the clutch plate will get free so the flywheel radiate but the clutch plate will not get rotate. This is the disengage position on clutch.

Diaphragm type clutch:

In this type of clutch instead of helical spring diaphragm spring is used the remaining part's spring type clutch.

Multi plate clutch:

- Diagram of multi plate clutch is shown in figure.

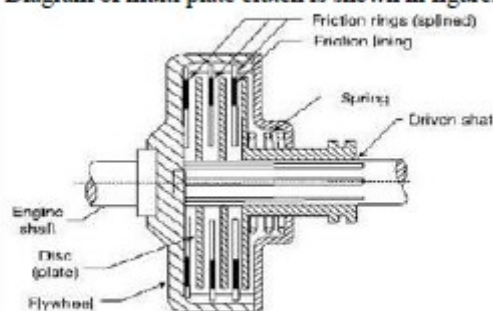

Multi plate clutch

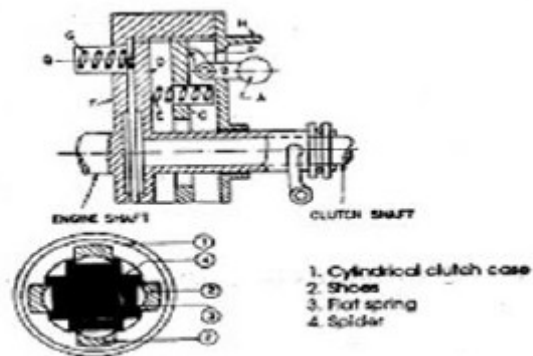

Centrifugal clutch

- In this type of clutch both the spring force the centrifugal force work to engage the clutch.
- When engine and vehicle stop the clutch is in disengage on passion. When engine get start and speed get increased the flyweight moves away (expand) and create a centrifugal force on pressure plate as well as on clutch plate as speed increases the force also get increases and the clutch get fully engage.
- When driver realeast accelerator pedal the speed of engine get reduced so that the centrifugal force also get reduce and clutch get disengage. This type of clutch does not require clutch pedal.
- This type of clutch is used on mopeds, and scooters.

Semi centrifugal clutch:

- Semi centrifugal clutch is shown in figure.

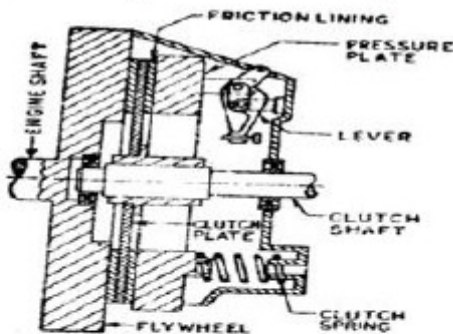

Semi centrifugal clutch

- In this type of clutch both the spring force the centrifugal force work to engage the clutch.
- Clutch plate one pressure plate is given the clutch plate as having external splice and engages with clutch box, the pressure plate are having internal saplings and engage with engine gears.

- The clutch plate and pressure plate are hold together with the help of helical spring.

Cone clutch:

- The cone clutch is shown in figure.

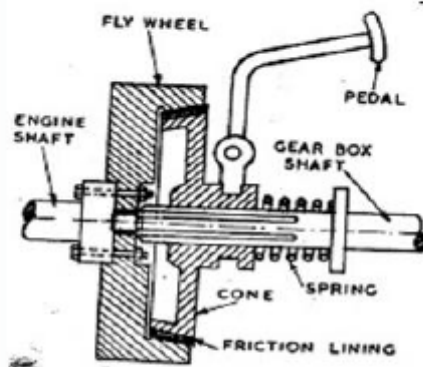

Cone clutch

- This clutch is having inner cone (flywheel) and outer surface of outer cone friction material is given to engage this two cone together helical spring is given at the center of outer cone the outer cone is having internal spines.
- Which are engage with clutch shaft? As the inner cone rotates, the outer cone also gets rotate which rotate the clutch shaft. In this type of clutch the frictional force is more than single plate clutch but dew to disengage disc advantages this type of clutch is not use in automobile vehicle.

Clutch operating mechanism:

Following type is the operating mechanism.

- **Mechanically operated clutch:** In this type mechanism linkages are connected in such a way that the force to operate the clutch gets increased.
- **Hydraulic operated clutch:** In this type mechanism the hydraulic oil is used to increase the pressure to operate the clutch. In this mechanism master cylinder and slave cylinder are used to increase the oil pressure.

Overdrive

By definition, an overdrive has a faster output speed than input speed. It's a speed increase -- the opposite of a reduction. In this transmission, engaging the overdrive accomplishes two things at once. If you read *How Torque Converters Work*, you learned about lockup torque converters. In order to improve efficiency, some cars have a mechanism that locks up the torque converter so that the output of the engine goes straight to the transmission.

In this transmission, when overdrive is engaged, a shaft that is attached to the housing of the torque converter (which is bolted to the flywheel of the engine) is connected by clutch to the planet carrier. The small sun gear freewheels, and the larger sun gear is held by the overdrive band. Nothing is connected to the turbine; the only input comes from the converter housing. Let's go back to our chart again, this time with the planet carrier for input, the sun gear fixed and the ring gear for output.

$$\text{Ratio} = 1 / (1 + S/R) = 1 / (1 + 36/72) = 0.67:1$$

So the output spins once for every two-thirds of a rotation of the engine. If the engine is turning at 2000 rotations per minute (RPM), the output speed is 3000 RPM. This allows cars to drive at freeway speed while the engine speed stays nice and slow.



A device for transmitting rotation between shafts by means of the acceleration and deceleration of a fluid such as oil. Also known as hydraulic coupling.

Fluid coupling

A device for transmitting rotation between shafts by means of the acceleration and deceleration of a hydraulic fluid. Structurally, a fluid coupling consists of an impeller on the input or driving shaft and a runner on the output or driven shaft. The two contain the fluid (see illustration). Impeller and runner are bladed rotors, the impeller acting as a pump and the runner reacting as a turbine. Basically, the impeller accelerates the fluid from near its axis, at which the tangential component of absolute velocity is low, to near its periphery, at which the

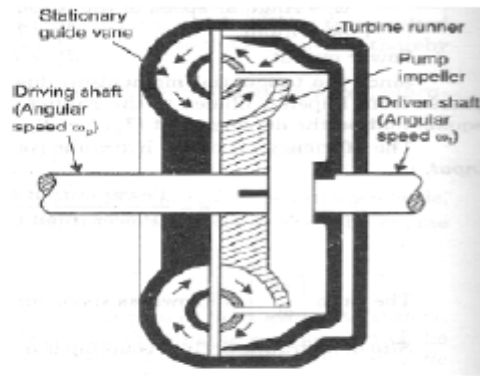

Hydraulic torque converter

Freewheel

In mechanical or automotive engineering, a **freewheel** or **overrunning clutch** is a device in a transmission that disengages the driveshaft from the driven shaft when the driven shaft rotates faster than the driveshaft. An overdrive is sometimes mistakenly called a freewheel, but is otherwise unrelated.

The condition of a driven shaft spinning faster than its driveshaft exists in most bicycles when the rider holds his or her feet still, no longer pushing the pedals. In a fixed-gear bicycle, without a freewheel, the rear wheel would drive the pedals around.

An analogous condition exists in an automobile with a manual transmission going down hill or any situation where the driver takes his or her foot off the gas pedal, closing the throttle; the wheels want to drive the engine, possibly at a higher RPM. In a two-stroke engine this can be a catastrophic situation: as many two stroke engines depend on a fuel/oil mixture for lubrication, a shortage of fuel to the engine would result in a shortage of oil in the cylinders, and the pistons would seize after a very short time causing extensive engine damage. Saab used a freewheel system in their two-stroke models for this reason and maintained it in the Saab 96 V4 and early Saab 99 for better fuel efficiency.

GEARS

Why do we need gears?

Let's think about cars. A car has a whole box full of gears—the gearbox—sitting between the crankshaft and the driveshaft. But what do they actually do?

A car engine makes power in a fairly violent way by harnessing the energy locked in gasoline. It works efficiently only when the pistons in the cylinders are pumping up and down at high speeds—about 10-20 times a second. Even when the car is simply idling by the roadside, the pistons still need to push up and down roughly 1000 times a minute or the engine will cut out. In other words, the engine has a minimum speed at which it works best of about 1000 rpm. But that creates an immediate problem because if the engine were connected directly to the wheels, they'd have a minimum speed of 1000rpm as well—which corresponds to roughly 120km/h or 75mph. Put it another way, if you switched on the ignition in a car like this, your wheels would instantly turn at 75mph! Suppose you put your foot down until the rev counter reached 7000 rpm. Now the

wheels should be turning round about seven times faster and you'd be going at 840 km/h or about 525 mph!

It sounds wildly exciting, but there's a snag. It takes a massive amount of force to get a car moving from a standstill and an engine that tries to go at top speed, right from the word go, won't generate enough force to do it. That's why cars need gearboxes. To begin with, a car needs a huge amount of force and very little speed to get it moving, so the driver uses a low gear. In effect, the gearbox is reducing the speed of the engine greatly but increasing its force in the same proportion to get the car moving. Once the car's going, the driver switches to a higher gear. More of the engine's power switches to making speed—and the car goes faster.

Transmission Manual Gear Box

- **Gear box**
 - **Introduction:-**
 - The mechanism that transmits engine power to the rear wheel (in case of rear wheel drive vehicle) or to the front wheel. (In front wheel drive vehicle) or to all the four wheel (in four wheel drive vehicles) is known as a transmission system.
 - It comprises of the following main units.
 - **Function of gear box:-**
 - The gear box and its associated units perform the following function on.
 - A gear box assists in variation of torque (or tractates effort) produced by the engine in accordance with the driving conditions.
 - A large torque is required at the start of the vehicle and a low torque at higher speeds.
 - It helps in smooth running of the vehicle at different speed since variation a torque induces.
 - **Types of transmission:**
 - Several kinds of transmission are employed on auto vehicles. These can be4 classified as follows.
- 1) **Manual transmission.**
 - 1) Sliding mesh gearbox.
 - 2) Constant mesh gearbox.
 - 3) Synchromesh gearbox.

4) Synchronmesh gear box with over drive.

2) Semi- Automatic transmission.

- 1) Electric controlled with a avid drive.
- 2) Electric controlled with over drive.
- 3) Fluid – torque drive.

3) Automatic drive.

- 1) Hydromantic drive.
- 2) Torque converter drive.

Sliding mesh gear box:

- Sliding mesh gear box shown in figure.

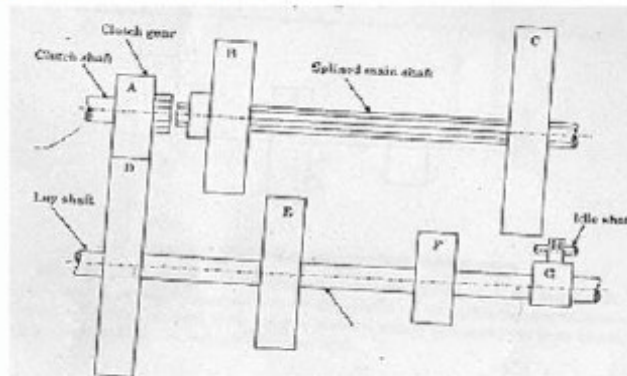

Sliding mesh gear box

- **1st Gear:-**

When driver wand's to move the vehicle he engage the 1st dog to the with the help of gear shifting levees as the dog slides on engage to the 1st gear it starts rotate with 1st gear and tends to rotate the main shaft like 1st gear operates.

- **2nd Gear:-**

As driver move fast again he slides the second dog and makes engage with second gear on main shaft (medium gear). As the dog engager to the second gear it rotates with second gear and tents to rotate the main shaft with high speed and low torque.

- **3rd Gear(Top gear):-**

To move the vehicle fast a gain the driver shift the second dog and make engages to the third or top gear. As the dog engages to the 3rd gear the dog rotates with gear and lends to rotate the main shaft with faster.

- **Constant mesh gear box:**
- Constant mesh gear box is the modified gear box of sliding mesh gear box.
- In this type of gear box all the gears of main shaft are errantly engaged with lay shaft gears.
- Do to that the possibility of bricking teeth gets reduced as well as the noise of gear box get ridicule.
- **Construction of gear box:-**
- The various sizes of helical gears are mounted on main shaft with bearing; they are free to rotate on main shaft.
- The dogs are provided on main shaft in between two gears such that they can slide the two spines the remaining construction is safe.
- Same as sliding mesh gear box.
- **Working:-**
- Constant mesh gear box shown in figure.

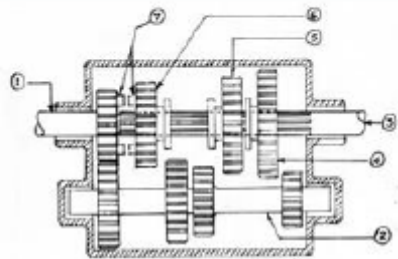

Gear box

- **Neutral gear:-**
When engine start and the clutch get rotate. If rotates clutch gear and lay shaft gear, all the gears on main shaft also get rotate because the no one dog is engage to the gear.
- **Reverse gear:-**
As the driver wand's to move the vehicle back he shifts the first dog towards digger gear which is engages to the idler gear. As the dog engages its start rotate with the gear in reverse or opposite direction and tends to rotate the main shaft in reverse direction.

Overdrive is a device interposed between the transmission (gear box) and propeller shaft to permit the propeller shaft to turn faster than or-over drive the transmission main shaft. It is so called because it provides a speed ratio over that of the high speed ratio. The overdrive permits the engine to operate only about 70 percent of the propeller shaft speed, when the vehicle is operating in the high speed ranges. The overdrive is suited to high powered cars employing three-speed gear boxes, since in order to produce flexible top gear performance a low gear final drive ;nay be necessary resulting in the engine running faster as high speeds than is desired. Generally an overdrive is fitted to the top gear only, but some sport cars have an over drive on

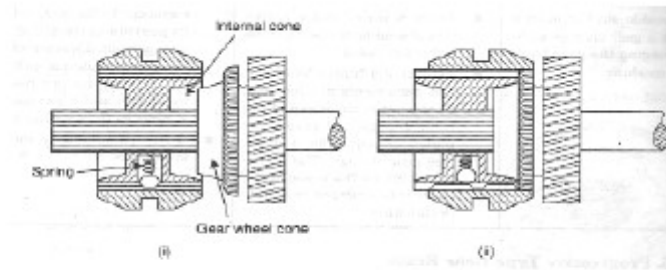

Synchromesh unit

Advantage. The synchromesh type of transmission has the big advantage of allowing smooth type and quick shifting of gears without danger of damaging the gears and without necessity for double clutching. The synchromesh gear box is considered the most advanced and has been adopted in most cars.

BRAKING SYSTEM

Braking System

- Brakes are employed to stop or slow down the speed of vehicle.
- When brake applied to wheel braking force is created that force oppose the speed of wheel or rotation of force.

Braking requirement:

- 1) The vehicle must stop in smallest distance.
- 2) It must act suddenly in emergency.
- 3) It must have strong braking force.
- 4) It must neither slip nor kid the vehicle.

And less heat production.

- 5) It must operate on least effort.

Types of brakes:

Breaks are divided into seven types as per there uses, functionality, locations etc.

- 1) **On the basis of purpose saved.**
 - a) Main brake.
 - b) Parking brake.
- 2) **On the basis of location.**
 - a) Wheel mounted.
 - b) Transmission mounted.
- 3) **On the basis of drivers ergonomics.**
 - a) Foot brake.
 - b) Hand brake.
- 4) **On the basis of actuating.**
 - a) Mechanical brake.
 - b) Hydraulic brake.
 - c) Air brake.
 - D) Electric brake.
- 5) **On the basis of construction.**
 - a) Drum brake.
 - b) Disc brake.
- 6) **On the basis of application of brake efforts.**
 - A) Manual brake.
 - b) Power brake.

c) Power assisted.

7) On the basis of action of brake shoes.

A) Internal expanding brake.

b) External contracting brake.

Brake Drum:

Construction of Brake Drum:

- The brake drum is mounted on axle hub and whole assembly is held in wheel to brake shoes are hinged on the back plate by means of pin expander is fitted in between shoes.
- The friction material is pasted or brette on brake shoes the expanded (cam) expander.
- The brake shoe and press on drum. Due to friction action brake will get applied.
- Brake drum is shown in figure.

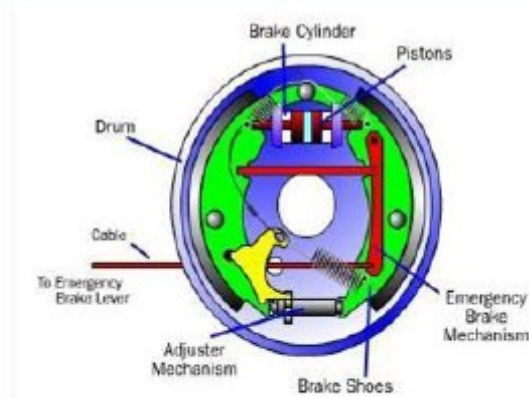

Brake Drum

Following parts used in break drum

- 1) Brake drum.
- 2) Back plate.
- 3) Brake shoe.
- 4) Brake lining.
- 5) Expander.
- 6) Anchor.
- 7) Returning spring.
- 8) Adjuster.

Disc brake:

Construction of disc brake:

- 1) Caliper or cylinder casing.
- 2) Rooter disc.
- 3) Piston.

- 4) Friction pad.
- 5) Pad supporting plate.
- 6) Bleeder plug.

Working of disc brake:

- Disc brake is shown in figure.

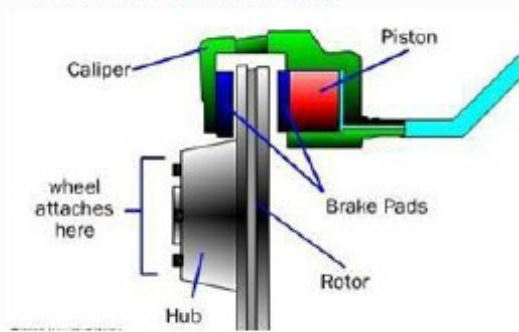

Disc brake

- The disc brake are applied hydraulically when the vehicle is to brake the brake fluid pumped by the master cylinder it then flows and pushes the piston and pad which makes friction with rotor disc and due to frictional action brake will get applied.

Mechanical brake:

- This brake system is operated by mechanical linkage.
- This brake system applied light vehicle two wheeler and some three wheeler this system required more efforts from driver and applied less force to the brake system to that system doesn't used on four wheeler or heavy vehicle.

Hydraulic brake system :-

- In this system the brake is operated with the help of oil pressure in this system master cylinder and wheel cylinder is most important part.
- This system is very popular on four wheeler vehicle basically light and medium vehicle.

Working of hydraulic brake system :-

- The diagram of hydraulic brake system is shown in figure.

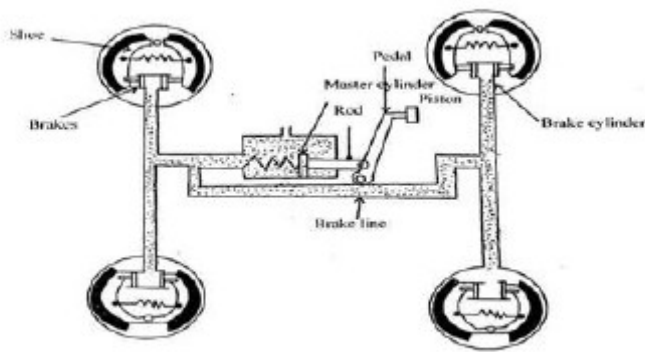

Hydraulic brake

- The brake system is fitted with brake oil when driver presses the brake pedal the master cylinder creates oil pressure and sent to wheel cylinder.
- Piston in wheel cylinder get expands due to oil pressure and the brake shoes also get expand and rub on brake shoes.
- Also get expand and rub on brake drum so that brake will get apply.

Master cylinder:

Master cylinder it is having following part:

- 1) Cylinder body.
- 2) Piston.
- 3) Primary cup.
- 4) Secondary cup.
- 5) Check valve.
- 6) Return spring.
- 7) Push rod.
- 8) Dust cover.

Working of master cylinder:

- The diagram of master cylinder is shown in figure.

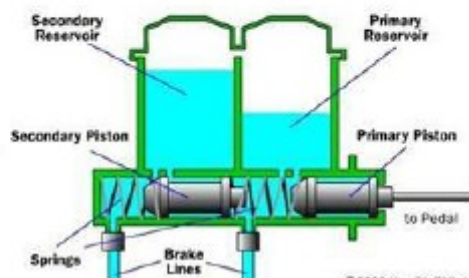

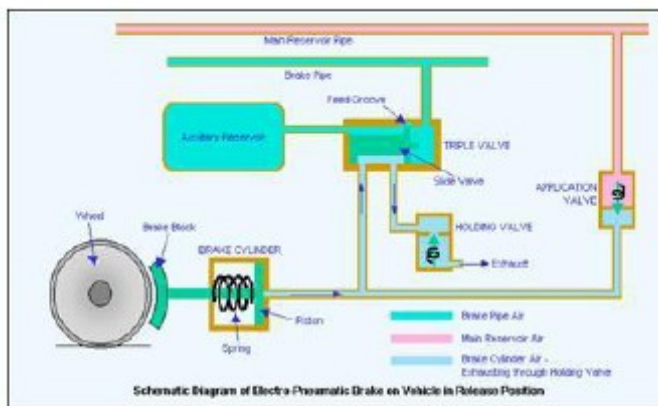

Pneumatic or Air Brake System

- Mostly it is used heavy vehicle the compressor run by engine sucked air from atmosphere and the piston of compressor compress the air and supplied to air tank.
- In between compressor and tank water separator is used which remove the water partial from air the air tank stores the air with pressure up to 8kg/cm².the safety valve is used in the tank to manifold constant air pressure.
- The pipe is connected from tank to brake valve and from brake valve to brake pedal the brake valve get open and pressure air flows from tank to brake chamber as soon as the air pressure inter in brake chamber the diaphragm get deflect which pushes the push rod for tarring the cam as the cam get turned it expand the brake shoe and brake will get applied.
- When driver release the brake pedal the brake valve gets closed and air pressure cannot supplied to the brake chamber so that brake will get not applied.

Brake lining:

The brake lining are high friction material beings used rub again the rotating brake drums and to stop them will the brake are applied for on efficient braking and longer lifer they are expect to have high standard of quality they are required to full fill various requirement such as given below:-

- 1) No water swells.
- 2) Low heat swells.
- 3) Low wear rate.
- 4) The high coefficient of normal and hot friction.
- 5) High strange and physically properties.

Brake lining material:

- The brake lining are made of asbestos, rubber, metallic particles, resin, minerals, and coefficient of friction modifies among these the asbestos is most important there for brake.
- Lining are commonly known as asbestos brake linings.

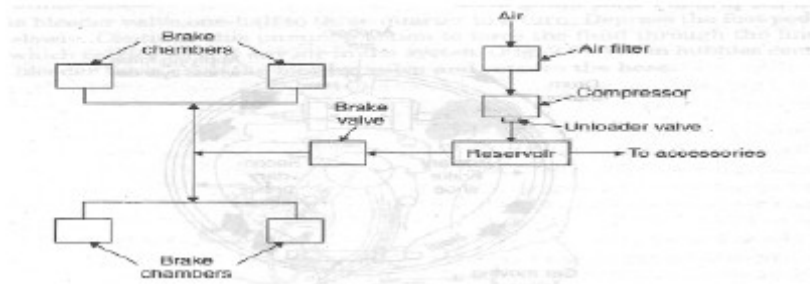

General arrangement of an air brake system.

When the foot pedal is pressed down, air pressure acts on the diaphragm of brake chamber. The diaphragm is linked with the brake shoe operating camshaft. The diaphragm is pushed outward in the brake chamber causing movement of brake shoe operating arm. The brake shoe expands outwards and holds the moving brake drums as they come into its contact. The brakes are thus applied. As soon as the pressure is released from the brake pedal, it comes back with the help of return spring. This results in closing of brake valve and release of pressure inside the brake chamber. The brake shoe operating cam moves in the reverse direction as a result of pressure release on the brake chamber. The brake shoe contracts inward with the help of retracting spring, releasing -the brake drum of the binding effect. The brakes are thus released.

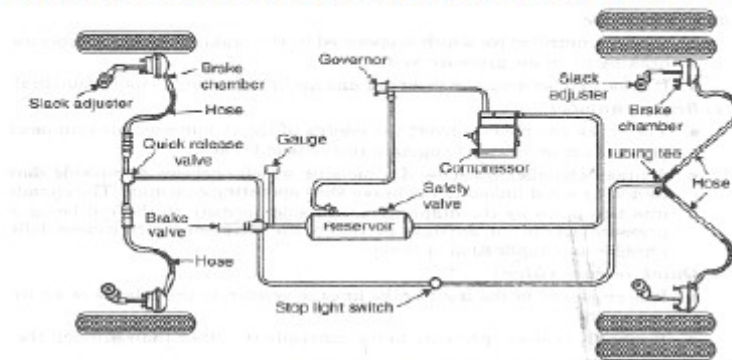

Layout of an air brake system for bus or truck.

Main parts of an air brake:

Following are the main parts of an air brake:

- (i) Air compressor.
- (ii) Unloaded valve.
- (iii) Reservoir.
- (iv) Brake valve.
- (v) Brake chamber.
- (vi) Quick release valve.
- (vii) Relay valve.
- (viii) Warning signal.

Advantages and disadvantages of air brakes

Air brakes entail the following *advantages*:

1. Much more powerful than the ordinary mechanical or hydraulic brakes (that is why these are exclusively used in *heavy vehicles*).
2. Simplified chassis design.
3. The compressed air from reservoir, apart from braking, can be used for tyre inflation, Windscreen wipers, horns etc.

Disadvantages:

1. Involve relatively more parts.
2. The air compressor uses a certain amount of the engine power. .

Loads on the Frame:

The frame experiences loads of different nature during motion of the vehicle. These loads, in turn, produce stresses and strains of various kinds. Generally, the frame sustains the following types of loads.

Flexural (or bending) load. It is produced in a vertical plane of the side members due to

- dead weight of the vehicle
- weight of the passengers
- engine torque
- braking torque

Flexural load also develops in lateral plane of the side members due to

- road camber
- cornering force
- side wind

The effect of flexural load is to cause flexural stresses which can be either tensile or compressive in nature. The compressive stress is resisted by placing thrust-taking members between the frame and the back axle. The tension is resisted by using material of sufficient strength.

Torsional load (or twisting moment). It is caused due to vertical load when the vehicle comes across a road bump. The twisting induces a shear stress in the frame. The frame is designed strong enough to resist torsion by providing

- torque-resisting members
- cross-members
- a radius rod
- Benzol-frame type torque members

Impact load. It is caused due to impact of wheels with road obstacles. It may result in distortion of the frame or its collapse. Bumpers and over-riders are used to sustain impact loads, thereby providing safety and longer life to the frame

MODULE-III

STEERING GEOMETRY AND FRONT AXLE

Steering System

Automobile is fragmentary without the steering system as it gives the vehicle a directional stability. Steering enables the driver to easily maneuver the vehicle according to the path. It doesn't mean that automotive, when developed, included steering mechanism. So, how the steering wheel which we see on today's car was invented? The automotive freaks, during those days, got the idea of steer the vehicle from boats which used tillers that helped them to turn left or right. The idea was implemented on automobiles too, but didn't last longer as it required more effort and the steering ability was almost poor. The ultimate discovery of the steering wheel was seen in the Pan hard model which was tested in the Paris-Rouen race. This innovation was then seen in every car model that followed and as such the round steering wheel became important and compulsory element of the car.

The steering system is however not as easy as it seems, where you simply turn the steering wheel that turns the road wheels. It is composed of complex mechanisms, linkages, joints and gears that actually make the wheels to turn.

Let us have a sneak peek on how the steering system actually works-We know that the basic function of steering system is to turn the wheels in the desired direction. However, it is interesting to note that when the vehicle is turned, the front wheels do not point in the same direction. Let's see how...



For a proper steering system, each of the wheels must follow different turning circle and when a perpendicular is drawn from centre of each wheel; all the perpendiculars will meet at one single point, which is known as instantaneous centre.

But then, the question still goes unanswered, that how these wheels actually turn?

Looking closely to the figure, we can see the complex mechanism of the steering system which makes the car wheels to turn. The system works on four bar chain mechanism where four links are flexibly connected with each other and imparting motion, to one of the link, will cause other links to move accordingly.

The steering wheel is directly connected to the steering gear, whose main function is to convert the rotary motion of the steering wheel into oscillatory motion of the pitman arm. This motion is transferred to the tie rod through the drag line, which moves the tie rod left or right, depending on the steering wheel input. The tie rod ends are connected to the pivots that actually turn the wheels.

The mechanism of steering remains same in all the steering systems, but the difference can be seen in the type of gearing arrangement used in the steering gearbox. The type of steering gear mechanism used in automobile power steering is listed below:

- Rack and Pinion Steering gear
- Worm and Sector steering gear
- Worm and Roller steering gear
- Cam and Lever steering gear
- Worm and Nut steering gear

Most common types include rack and pinion and re-circulating ball (Worm and nut) type arrangement.

1. Rack and Pinion Steering

The system consists of a pinion attached to the steering shaft, which meshes with the flat rack on the drag line. Pinion imparts left or right motion to the rack, which causes the tie rods to move the road wheels consequently. This mechanism is usually adopted universally in all the cars that are available today with some major improvements.

Earlier, steering system was robust, though it was quite difficult and heavy to use. The need of more flexible and smooth system was desired and as such some of the vital experiments in 1920 gave birth to the power steering system. The entire credit goes to Francis W. Davis who was an engineer in automotive company. With his efforts, power steering system began to be used commercially in all the cars.

2. Worm and Sector steering gear

In this type of steering mechanism, worm is connected at the end of steering shaft and sector is mounted on a sector shaft. The sector looks like a ball and worm looks like a gear. The teeth of the worm mesh with the teeth of the sector. To provide free play, worm is mounted on a bearing. It is also known as "Pitman arm shaft"

3. Worm and Roller steering gear

Worm and roller is similar to the worm and sector type of steering mechanism. A toothed roller is mounted on a roller shaft and worm gear is mounted on a steering shaft. Gear tooth of worm gear meshes with that of the roller and motion is transmitted. The roller is mounted on a ball bearing. This mechanism has low friction compared to Worm and Sector mechanism and is widely used on American passenger cars.

4. Cam and Lever steering gear

Cam and lever is similar to the worm and sector gear mechanism. The worm is replaced with cam and sector is replaced with a lever. Cam is engaged by a bearing and lever, carries two studs that are mounted on bearing. As the driver turns the steering wheel, studs move up and down on the cam so lever and pitman arm shaft rotates.

5. Worm and Nut steering gear

A nut is meshed with the worm and screws up and down relative to the movement of the worm. This is also known as "re-circulating ball type" mechanism. Nut is used with ball that reduces the friction and power loss.

Without increasing further impatience, let us look the power steering system implemented on a normal rack and pinion steering system.

Power steering refers to the use of hydraulic power in assisting the steering motion. When coupled with any of the steering system, the power steering makes use of pump which forces the fluid under pressure, to help the steering gearbox, to overcome the friction and easily turn the gears and impart movement to the road wheels. Power steering makes steering wheel to turn easily and also a small effort, on steering wheel, will give sharp turning of road wheels.

Power steering got a new dimension with the use of electric motor and sensors that do not use engine power but run separately using battery. The sensors are used to sense the torque and motion is applied to the steering wheel. Based on this, the control unit, powers the motor to assist in steering. At this juncture, it is also important to know the term steering ratio which helps to determine the steering ability of particular steering system. Steering ratio is defined as the ratio of number of degrees that the steering wheel turns to the number degrees of wheel turn.

Steering ratio for cars vary from 12:1 to 20:1. E.g. If we want to turn the wheels to 20 degree by one complete revolution of steering wheel, the ratio will be 360:20 or 18:1.

A higher steering ratio requires more turns of steering wheel but effort required will be less.

POWER STEERING

The increased use of large section low-pressure balloon tyres has aggravated the steering problem due to the greater contact area between the tyre and ground. The driver requires a greater force to be exerted on the steering wheel for steering the heavy vehicle or heavily loaded commercial vehicle, especially when the vehicle has to take a sharp turn. Power steering makes it easier to turn sharp corners. It is fitted not only to heavy commercial vehicles but also to heavy and medium weight cars. It is usually arranged to be operative when the effort at the steering wheel exceeds a pre-determined value. When this effort is exceeded, a valve directs the working fluid to the appropriate side of the power cylinder, and this results in the steered wheels being turned in the desired direction. The working fluid is high quality lubricating oil having a viscosity rating equivalent to ASE low for normal conditions. The actual amount of assistance given depends upon the resistance offered to movement of the road wheels.

There are usually two general types of power steering systems:

1. Integral power steering, in which the power operating assembly is part of the steering gear.
2. Linkage power steering, in which the power operating assembly is part of the linkage.

INTEGRAL POWER STEERING

The integral power steering is designed to receive power assistance only when the effort at the steering wheel rim exceeds two pounds and is up to five pounds. It consists of a worm-and-ball-bearing nut steering gear with a hydraulic rack piston, concentric with the worm shaft, which can aid in moving the nut in either direction by means of hydraulic pressure. A reaction control valve is linked to the worm shaft thrust bearing through a link and actuator lever. Any moment of the thrust bearing causes the control valve to move which opens and closes oil passage between the valve body and the housing of the gear and pinion assembly.

The working of the integral power steering during a right turn is shown. When the vehicle is going straight-ahead, the oil flows from the pump, through the open center of the valves and back to reservoir.

New Technologies and Innovations in the Steering System

Many new innovations in steering system are available today that give the best possible directional stability to the cars with extreme comfort levels. Some of the improvements include 4-wheel steering which assists in steering all the four wheels of the car. This helps in maneuvering the car at high speeds. Some of the cars today also include a system known as speed sensitive steering, which uses a concept that during high speed steering requirements are less and as such the power assistance is reduced. It is increased during low speeds as more steering effort is needed. Future developments in the steering system are being done and experts have come up with an idea of steer-by-wire mechanism in which the steering will be achieved completely using electronics. The main aim of the system is to eliminate the complex system of linkages and joints giving more space for engine and interior designing aspects.

Wheel Alignment

Wheel alignment refers to the positioning of the front wheels and steering mechanism that gives the vehicle directional stability, promotes ease of steering and reduces tire wear to a minimum.

A wheel is said to have directional stability or control if it can:

- run straight down a road,
- enter and leave a turn easily, and
- resist road shocks.

The front wheel alignment depends upon the following factors:

Factors pertaining to steering geometry:

1. Camber
2. King pin inclination
3. Caster
4. Toe-in

Factors pertaining to front wheel condition:

1. Balance of wheels
2. Inflation of tyres
3. Brake adjustments.

Camber:

Camber is the tilting in or out of the front wheels from the vertical when viewed from the front of the vehicle. If the top of the wheel tilts out, it has "positive" camber. If the top of the wheel tilts in, it has "negative" camber. The amount of tilt measured in degrees from the vertical, is called "camber angle". Any amount of camber, positive or negative, tends to cause uneven or more tyre wear on one side than on the other side. Camber should not exceed two degrees. The front wheels are not usually mounted parallel to each, but are fitted outward slightly at the top and inward at the bottom to have positive camber. The purpose of the camber is to prevent the top of the wheels from tilting inward too much because of excessive loads or play in kingpins and wheel bearing. When the vehicle is loaded and rolling along on the road, the load will just bring the wheels to a vertical position. The opposite is true in case of vehicles having negative camber.

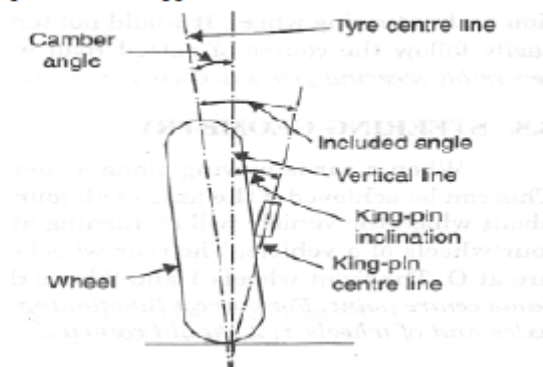

King-pin inclination:

The king-pin inclination (or steering axle inclination) is the angle between the vertical line and centre of the kingpin or steering axle, when viewed from the front of the vehicle (Fig.) The king-pin inclination is absolutely necessary due to the following reasons:

- (i) It helps the car to have steering stability.
- (ii) It makes the operation of the steering quite easy particularly when the vehicle is stationary.
- (iii) It helps in reducing the wear on the tyre.

Included angle:

The combined camber and king-pin inclination is called the "included angle". This angle is important because it determines the point of intersection of the wheel and king pin centre lines. This in turn determines whether the wheel will tend to toe-out or toe-in.

- If the point of intersection is above the ground, the wheel tends to toe-in.
- If it is below the ground, the wheel tends to toe-out.
- If it is at the ground, the wheel keeps its straight position without any tendency to toe-in or toe-out. In this position the steering is called centre point steering.

Caster:

The angle between the king-pin centre line (or steering axis) and the vertical, in the plane of the wheel is called Caster angle. If the King-pin centre line meets the ground at a point ahead of the vertical centre line, as is shown in Fig. 8.11 it is called positive caster while if it is behind the vertical, wheel centre Front line it is called negative caster. The caster angle in modern vehicles range from 2° to 8° .

The purpose of caster is to give a trailing effect to the front wheels. When the wheel trills the line of weight, that is, moves in the same direction as the vehicle, it is easy to steer a straight course. Fig. Caster angle (Positive).

- . The positive caster in wheels results in a natural tendency in the wheels to toe-in. The negative caster would have the opposite effect, i.e., the wheels will tend to toe-out.
- The positive caster increases the effort required to steer and tries to keep the wheels straight ahead. In the heavy duty trucks negative caster is provided, this makes steering easier.

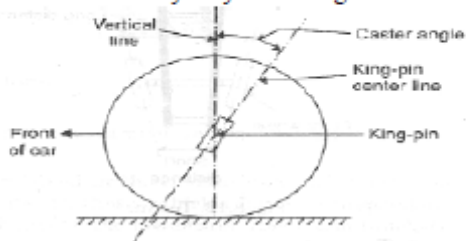

Caster angle (Positive)

When both the wheels have the same positive caster, both will have equal tendencies to toe-in, which will be balanced by each other because track rod is provided to maintain the distance between the wheels rigidly. However, when the caster at the two wheels is not equal, the tendency to toe-in at the wheel with larger caster will be more which will cause the vehicle to pull constantly towards the side of the wheel with lesser caster. . Since the change of caster angle results in the change of the other angles of the steering geometry, i.e., camber, king-pin inclination and toe-in or toe-out, it is very important that this angle is adjusted first of all, while doing the adjustment job. About 3° of caster gives good results.

Differential assembly

Differential is the mechanism by means of which outer wheel runs faster than the inner wheel while taking a turn or moving over upheaval road. Differential is a part of the inner axle housing assembly, which includes the differential, rear axles, wheels and bearings. The differential consists of a system of gears arranged in such a way that connects the propeller shaft with the rear axles. The purpose of the differential is to provide the relative movement to the two rear wheels when the car is taking a turn. The torque transmitted to each wheel is, however, always equal. Differentials are used in rear drive axle of front-engine, rear-wheel drive vehicles. Differentials are also used in the Trans axles on front-engine, front-wheel drive vehicles. Also, four-wheel drive vehicles have differential at both the front and rear wheels. In addition, some four-wheel-drive vehicles have a third differential in the transfer case.

Construction of differential

Fig. Shows the various parts of a differential unit. The bevel pinion is fixed to the propeller shaft which rotates the crown wheel. The crown-wheel has another unit called the differential unit. It consists of two bevel gears (sun gears) and two bevel pinions (planet pinions). The bevel gears are in contact with the half shafts of the rear axle. When the crown wheel is rotating, it rotates the differential unit. The bevel (sun) gears of the differential rotate the two half shafts.

Operation of differential:

When the car is on a straight road, the ring gear, differential case, differential pinion gears, and two differential side gears all turn as a unit. The two differential pinion gears do not rotate on the pinion shaft. This is because they exert equal force on the two differential side gears. As a result, the side gears turn at the same speed as the ring gear, which causes both drive wheels to turn at the same speed also. However, when the car begins to round a curve, the *differential pinion gears rotate on the pinion shaft*. This permits the *outer wheel to turn faster than the inner wheel*.

Suppose one wheel turns slower than the other as the car rounds a curve. As the differential

case rotates, the pinion gears must rotate on their shaft. This occurs because the pinion gears must walk around the slower-turning differential-side gear. Therefore, the pinion gears carry additional rotary motion to the faster-turning outer wheel on the turn. The action in a typical turn is shown in Fig. The differential speed is considered to be 100 percent. The rotating action of the pinion gears carries 90 percent of this speed to the slower-rotating inner wheel. It sends 110 percent of the speed to the faster-rotating outer wheel. This is how the differential allows one drive wheel to turn faster than the other.

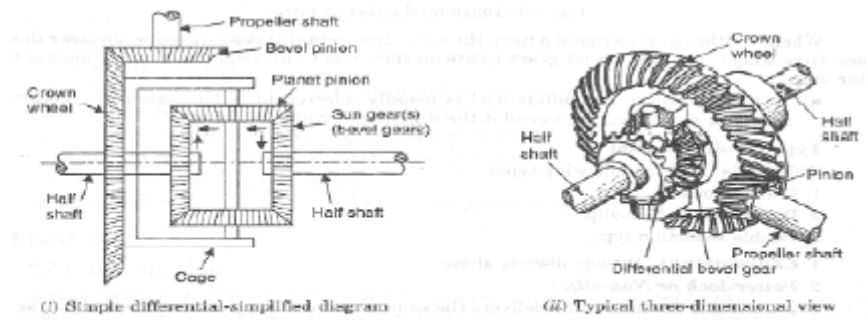

Whenever the car goes round a turn, the outer drive wheel travels a greater distance than the inner drive wheel. The two pinion gears rotate on their shaft and send more rotary motion to the Outer wheel. The gear ratio in the differential is usually referred to as the axle ratio. However it would be more accurate to call it the differential ratio.

Types of differential:

Differential is of the following types:

1. Conventional.
2. Power-lock or Non-slip.
3. Double reduction type.

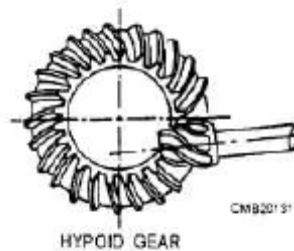
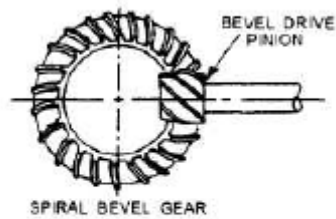

FINAL DRIVE A final drive is that part of a power transmission system between the drive shaft and the differential. Its function is to change the direction of the power transmitted by the drive shaft through 90 degrees to the driving axles. At the same time, it provides a fixed reduction between the speed of the drive shaft and the axle driving the wheels. The reduction or gear ratio of the final drive is determined by dividing the number of teeth on the ring gear by the number of teeth on the pinion gear. In passenger vehicles, this speed reduction varies from about 3:1 to 5:1. In trucks it varies from about 5:1 to 11:1. To calculate rear axle ratio, count the number of teeth on each gear. Then divide the number of pinion teeth into the number of ring gear teeth. For example, if the pinion gear has 10 teeth and the ring gear has 30 (30 divided by 10), the rear axle ratio would be 3:1. Manufacturers install a rear axle ratio that provides a compromise between performance and economy. The average passenger car ratio is 3.50:1. The higher axle ratio

PROPELLER SHAFT

A propeller shaft is also known as drive shaft. It is connected to the universal coupling (UC) at its two ends. It incorporates a sliding joint in its construction. The sliding joint has a male spline on the propeller shaft and a female spline on the sleeve. The up and down movement of the rear axle is accounted for by the universal joints when the moving vehicle experiences rough road conditions. The up and down motion causes a change in the length of the propeller shaft which is adjusted by the sliding joint. This joint is provided at the gearbox end.

The propeller shaft sustains torsion (twisting) during its operation. It is, therefore, made of solid circular or hollow circular (tubular) cross-section. A tubular section is commonly used as it is the strongest and best suited to resist the torque. It has to be designed to withstand vibration

effects also since the phenomenon of whirling may be critical at higher speeds.

There are other designs also in which slip arrangement is different. These designs incorporate

1. A solid shaft and a splined slip yoke,
2. A rubber element between the two sliding tubes.

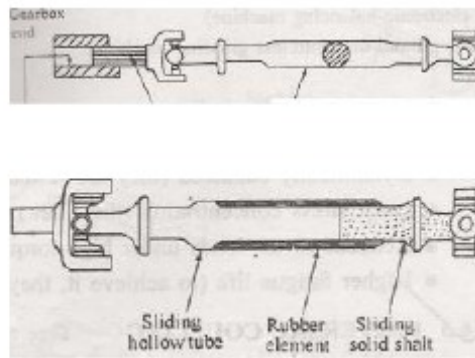

Merally splined bush

Splined slip yoke

Solid section propeller shaft

Details of propeller shafts having

(a) a solid section and a splined slip yoke, and (b) a rubber element between a sliding shaft and a tube

AXLE

An axle is a central shaft for a rotating wheel or gear. On wheeled vehicles, the axle may be fixed to the wheels, rotating with them, or fixed to the vehicle, with the wheels rotating around the axle. In the former case, bearings or bushings are provided at the mounting points where the axle is supported. In the latter case, a bearing or bushing sits inside a central hole in the wheel to

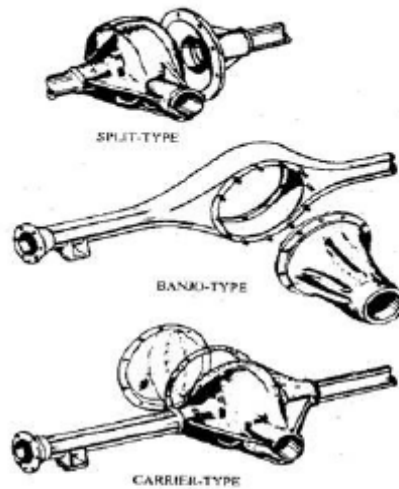

Loading of different axle-hub arrangements

- A. Semi-floating axle hub.
- B. Three-quarter floating axle hub.
- C. Fully floating axle hub.

Axle shafts are divided into semi-floating, three-quarter floating and fully floating depending on the stresses to which the shaft is subjected. Axle half-shafts are situated on each side of the final drive and convey motion to the road-wheels. There are basically three different arrangements of supporting axle wheel hubs on the rear-axle casing. These include :

- (i) Semi-floating axle hub (commonly used on cars).
- (ii) Three quarter floating axle hub (rarely used today).
- (iii) Fully floating axle hub (commonly used on heavy vehicles).

Figure demonstrates how loads are resisted with different axle-hub arrangements. A tough, hard material is used for the axle shaft to withstand the various stresses, resist spline wear and provide good resistance to fatigue. Medium carbon alloy steel containing nickel, chromium and molybdenum is generally used to manufacture axle shafts.

Semi-floating Axle Hub.

The road-wheel is attached to the axle hub, which is an extension of the axle half-shaft. A single bearing inside the tubular axle-casing supports the outer end of the shaft. The inner end of the shaft is splined and supported by the final-drive unit, which itself is mounted on bearings within the axle casing (Fig. 26.52A). The semi-floating axle along with its overhanging hub is subjected to the driving torque as well as to both vertical and horizontal loads. The vertical load produces a

shearing force, and the distance between the wheel and the suspension-spring seat on the axle causes a bending moment, the reaction of which is shared between the axle bearing and the final-drive-unit bearings. The horizontal load due to tilting of the vehicle, cornering centrifugal force, or side wind gives rise to both side-thrust and a bending moment. This bending moment may add to the vertical bending moment or may oppose it, depending on the direction of application of the side-force. A semi floating axle, suitable for small and medium sized cars, is illustrated in Fig. 26.53. The axle half shaft and flanged hub are forged from a single piece of nickel chrome steel. The hub end of the shaft is provided with a larger diameter than the rest of its length, which resists the vertical and horizontal loads. The outer face of the flanged hub is shouldered so that it centralizes accurately the brake drum. The flange is provided with evenly spaced holes around it for wheel studs.

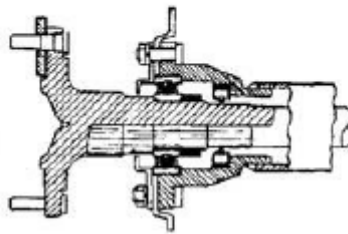

Fig..Semi-floatingball-race-bearing.

A pre-greased and sealed deep groove ball-race bearing is pressed over and along the shaft up to its shoulder. The bearing is sandwiched on one side by the axle-casing and on the other by the brake back-plate and the retaining plate by four nuts and bolts. To prevent excess oil leakage to the end of the axle-casing, a radial-lip oil-seal is pressed into a recess in the casing. Oil level of the final-drive is considerably lower than the axle shaft. However, the large amount of splash may cause the lubricant to spread along the shaft and enter the brake drum. An oil retainer is fitted at the hub end and the lip of the seal is positioned towards the final drive in the sealing arrangement. A semi-floating axle shown in Fig. 26.54 uses a taper-roller bearing, which is suitable for larger and higher-performance cars because of its greater load-carrying capacity. A separate hub is wedged on to a keyed and tapered half-shaft and a castellated nut holds it in position. The taper-roller-bearing inner cone fits with a light force inside the mouth of the casing. The exact position of the bearing in the casing is provided by shims packed between the casing flange and the brake back-plate. Increasing the thickness of the shims on one side and decreasing it on the other shifts both half-shafts further to one side relative to the axle casing. On either road-wheel the outward thrust is absorbed by the adjacent hub bearing, while inward thrust is transmitted to the opposite bearing through the axle half-shafts and a slotted axle-shaft spacer (not shown). Therefore, each hub bearing takes thrust in one direction only.

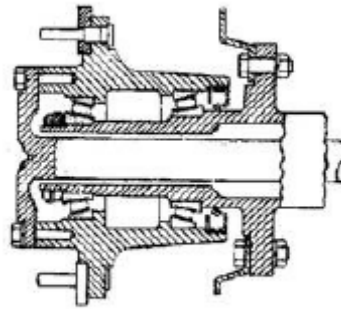

Fig. Fully floating axle.

Front Axle and Steering System

Front axle carries the weight of the front part of the automobile as well as facilitates steering and absorbs shocks due to road surface variations. The front axles are generally dead axles, but are live axles in small cars of compact designs and also in case of four-wheel drive. The steering system converts the rotary motion of the driver's steering wheel into the angular turning of the front wheels as well as to multiply the driver's effort with leverage or mechanical advantage for turning the wheels. The steering system, in addition to directing the vehicle in a particular direction must be arranged geometrically in such a way so that the wheels undergo true rolling motion without slipping or scuffing. Moreover, the steering must be light and stable with a certain degree of self-adjusting ability. Steering systems may also be power assisted. The chapter discusses the front axle construction and its alignment, and steering geometry and steering systems.

Front Axle

The front axle (Fig. 27.1) is designed to transmit the weight of the automobile from the springs to the front wheels, turning right or left as required. To prevent interference due to front engine location, and for providing greater stability and safety at high speeds by lowering the centre of gravity of the road vehicles, the entire centre portion of the axle is dropped. As shown in Fig. 27.1, front axle includes the axle-beam, stub-axles with brake assemblies, a ack-rod and stub-xlearn. Front axles can be live axles and dead axles. A live front axle contains the differential mechanism through which the engine power flows towards the front wheels. For steering the front wheels, constant velocity joints are contained in the axle half shafts. Without affecting the power flow through the half shafts, these joints help in turning the stub axles around the king-pin. The front axles are generally dead axles, which does not transmit power. The front wheel hubs rotate on antifriction bearings of tapered-roller type on the steering spindles, which are an integral part of steering knuckles. To permit the wheels to be turned by the steering gear, the steering spindle and steering knuckle assemblies are hinged on the end of axle. The pin that forms the pivot of this hinge is known as king pin or steering knuckle pin. Generally dead front axles are three types. In the Elliot type front axles the yoke for king spindle is located on the ends of I-beam. The axle ends are forked to hold the steering knuckle extension between them. The

reverse Elliot front axles have hinged spindle yoke on spindle itself instead of on the axle. The forked portion is integral with the steering knuckle. This type is commonly used as this facilitates the mounting of brake backing plate on the forged legs of the steering knuckle. In the Lemoine type front axle, instead of a yoke type hinge, an L-shaped spindle is used which is attached to the end of the axle by means of a pivot. It is normally used in tractors.



Fig. Frontaxle.

The axle beam in use is of I or H-section and is manufactured from alloy forged steel for rigidity and strength. As compared to dead front axles, a totally different type of swiveling mechanism is used on the live front axle. To connect the wheel hub axles with driving axle shafts, constant velocity joints are used for the vehicles fitted with the front live axles. Tracta, Rzeppa (or heppa) or Bendix constant velocity or universal joints are normally used. Front axles are subjected to both bending and shear stresses. In the static condition, the axle may be considered as a beam supported vertically upward at the ends i.e. at the centre of the wheels and loaded vertically downward at the centers of the spring pads. The vertical bending moment thus caused is zero at the point of support and rises linearly to a maximum at the point of loading and then remains constant.

Thus the maximum bending moment = Wl , where, W = The load on one wheel, l = The distance between the centre of wheel and the spring pad, m Under dynamic conditions, the vertical bending moment is increased due to road roughness. But its estimate is difficult and hence is generally accounted for through a factor of safety. The front axle also experiences a horizontal bending moment because of resistance to motion and this is of a nature similar to the vertical one but of very small magnitude and hence can be neglected except in those situations when it is comparatively large.

The resistance to motion also causes a torque in the case of drop type front axle as shown in Fig. 27.2. Thus the portions projected after the spring pads are subjected to combined bending and torsion.

SUSPENSION SYSTEM

Introduction

The modern automobile has come along way since the days when “just being self propelled” was enough to satisfy the car owner. Improvement in suspension, increased strength & durability of components, and advances in tire design and construction has made large contributions to tiding comfort and driving safety.

Basically, suspension refers to the use of front and rear springs to suspend a vehicles frame, body, engine & power train above the wheels. These relatively heavy assemblies constitute what is known as “Sprung” weight. “Unsprung” weight, on the other hand, includes wheels and tire, break assemblies and other structural members not supported by the springs.

The springs used in today's cars and trucks are engineered in a wide variety of types, shapes, sizes, rates and capacities. Types include leaf springs, coil springs, air springs and torsion bars. These are used in sets of four per vehicle, or they are paired off in various combinations and are attached to the vehicle by a number of different mounting techniques.

Front suspension types

there are two types of front suspension in general use: the independent system & the solid axle system. Independent suspensions usually operate through heavy-duty coil springs or torsion bars and direct, double acting shock absorbers. In solid axle construction, the axle beam and wheel assemblies are connected to the car by leaf springs and direct or in-direct shock absorber.

With the solid axle setup, the steering knuckle and wheel spindle assemblies are

Connected to the axle beam by bronze-bushed kingpins, or spindle bolts, which provide pivot points for each front wheel. Modern independent front wheel suspension systems use ball joints, or spherical joints, accomplish the purpose. In operation, the swiveling action of the ball joints allows the wheel and spindle assemblies to be turned left and right and to move up & down with changed in road service.

Leaf spring

Front leaf, or late, springs are used in conjunction with solid axle beams in most truck applications. Rear leaf springs are used on trucks and some passenger cars. Single leaf or multi-leaf springs are usually mounted longitudinally over the front axle beam or under the rear axle housing.

The spring center bolt fastens the leaves together, and its head locates the spring in the front axle beam or saddle on the rear axle housing. U-bolts clamp the spring firmly in place and keep it from shifting. Eyebolts, brackets and shackles attach it to the frame at each end.

In many cases, leaf springs are used at the rear of the vehicle in combination with another type of spring in front. Chrysler, for example, uses leaf springs at the rear, torsion bars in front.

For many years, Ford used leaf springs at rear, coil springs in front. Now, full-size cars have coil spring suspension, front and rear. Ford's small cars have coil springs in front; leaf springs at rear. Buick still uses coil spring at all around. In some foreign cars, torsion bars are used front and rear; in others, leaf springs are mounted crosswise for use with independently suspended wheels.

Rear leaf spring in U.S. vehicles generally are placed parallel to the frame to absorb the torque of the driving wheels the front half of each leaf spring acts like a radius rod or control arm to transmit the driving force from the rear wheels to the frame. With this suspension setup, the leaf springs also serve as stabilizer side sway of the chassis.

Coil springs

Many independent front suspension systems incorporate compression-type coil springs mounted between the lower control arms and spring housing in the frame. Others have the coil springs mounted above the upper control arms, compressed between a pivoting spring seat bolted to the control arm and a spring tower formed in the front-end sheet metal.

Generally, the upper control arm pivots on a bushing and shaft assembly, which is bolted to the frame. The lower arm pivots on a bushing and shaft assembly or on a bolt cross frame member. When the lower control arm is not the A-frame type, its supported by strut, which runs diagonally from the lower control arm to a bracket attached to the frame. On some models, this strut serves as a support; on others, it provides a means of adjusting caster.

Stabilizers or sway bars are used in conjunction with front suspension on many cars to dampen road shocks and minimize road sway. These bars are bracketed to the frame front cross member and extend from one lower control arm to the other.

Actually, the S.L.A (short-long arms) system of front suspension has been adopted almost universally for passenger cars. The proportional lengths of the upper and lower control arms (and their engineered placement) are designed to keep the rise and fall of each front wheel in a vertical plane. With this arrangement, changes in wheel angularity, weight balance and tire-scuffing tendencies are negligible when compared with solid axle suspension.

Another coil spring setup that is gaining application in small cars is Macpherson strut suspension. It combines coil spring, shock absorber and strut in a single assembly.

When coil springs are used in both front and rear suspension, three or four control arms are placed between the rear housing axle and the frame to carry driving and braking torque. The lower control arms pivot in the frame members and sometimes support the rear coil spring to provide for up & down movement of the axle & wheel assembly.

In addition, a sway bar (track bar) is usually attached from the upper control arm to the frame side rail to hold the rear axle housing in proper alignment with the frame and to prevent side sway of the body. However, if the rear coil springs are mounted between the frame and the swinging half axle, the independently suspended rear wheels have a sturdy axle housing attached to the differential housing which, in turns, is bolted to the frame.

Torsion bars

Although torsion bars were and are used extensively on European cars, this type of suspension system received only token attention from the U.S. manufacturers until Chrysler developed their system in the early 1950s. Before that only a few buses, trailers and race cars were equipped with torsion bar suspension.

Basically, torsion bar suspension is a method of utilizing the flexibility of a steel bar or tube twisting lengthwise to provide spring action. Instead of the flexing action of a leaf spring, the torsion bar twists to exert resistance against up and down movement.

For example, an independently suspended front system with torsion bars mounted lengthwise would have one end of the bars anchored to the car frame and the other end attached to the lower control arms. With each rise and fall of a front wheel, the control arm pivots up and down, twisting the torsion bar along its length to absorb road chock and cushion the ride.

Chrysler cars are equipped with left and rights, non-interchangeable, front torsion bars with hex-shaped ends. In position, the bars extend from hex-shaped rear anchors in the frame cross members to hex-shaped holes in the front lower control arm, adjusting bolts are provided at the front mounting to increase or decrease torsion bar twist and thereby control front suspension height. Over the years, Chrysler has made many improvements in the system, including lengthening the torsion to lower the spring rate; adding a removable rear anchor cross member that rubber-isolated from the frame; devising a plastic plug and a balloon seal for the rear anchor. Olds mobile Tornado and Cadillac Eldorado front wheel drive cars also use lengthwise mounted

torsion to support the front and to provide for high adjustment.

Torsion bars can also be used laterally to provide spring action for front and/or rear wheel independent suspension system. Older Volkswagen cars offer a unique torsion bar arrangement with all four wheels independently suspended, but with two different torsion bar setup in use. At the front, two laminated square torsion bars in separate axle tubes are anchored at the center to counteract twisting and lateral movement. Each has a lever or torsion arm attached to its outer end. Ball joints connect the torsion arms to the steering knuckle. The wheel spindle trails behind the axle and tends to swing in an arc when moved up and down by road irregularities.

At the rear, Volkswagen utilized one short, round torsion bar on each side. These bars are splined at each both ends and anchored in the center of the frame cross member. The outer ends of the torsion bars carry the spring plates to which the wheels are attached. Here, too, the wheels follow behind the torsion bar on "trailing arms".

Air suspension

Air suspension systems are designed to cushion the ride and keep the car, bus or truck level fore and aft and at a constant height regardless of load. Air suspension was introduced on many luxury cars in the late 1950s, but it was dropped after one or two model years. Recently, however, new leveling systems have been researched and developed for passenger car use, including air-adjustable rear shock absorber.

A typical air suspension system consists of an engine-driven air compressor, supply tank, filter or condenser, valves, piping, controls and air springs or bellows. In operation, the air compressor maintains a constant pressure in the supply tank. Air is piped to the control valves, which feed air to each spring as needed. Pressure is automatically increased on either side or at front or rear as required to keep the car level and to keep any desired height from the road (within limit of system).

Automatic level control

Air springs are not used in Cadillac's automatic level control system. Rather, the rear shock absorber extends or compresses to bring the rear of the car to the same level as the front. This automatic system utilizes an air compressor, reservoir tank assembly, pressure regulator, hoses, flexible airlines, height control valve and special shock absorbers.

Older Ford cars used one of two leveling systems that utilize air bags in conjunction with rear coil springs. The automatic system consists of air reservoir and pump, leveling valve, air bags, nylon tubing & metal fittings and connectors. The manual system has similar air bags connected

to lines leading to the trunk of the car where an air valve connection permits leveling by application of air under pressure from an outside compressed air source.

Late model Ford cars carry an option for a rear suspension automatic load-leveling system that functions only after a load (approximately 400 lbs.) is added to the vehicle. When the load lowers the vehicle to a specific level, air sleeve rear shock absorber inflates and extend, raising the vehicle to design height. When the load is removed, the air sleeve shock absorbers deflate and lower the vehicle to design height.

Ford's rear suspension automatic load-leveling system includes a compressor and air bleed valve, pressure reservoir tank height control valve and link, three flexible nylon air lines and a rubber vacuum hose.

The compressor maintains 60 or 125 psi in the system. The air bleed valve permits air to bleed for testing and servicing or for hooking up a trailer. The pressure tank stores high - pressure air. The height control valve and link maintain vehicle design height at rear.

The lever on the height control valves is attached to the rear suspension upper arm by means of the link. The control valves senses riding height and either admits or exhausts height pressure air to or from the air sleeve shock absorber. A time delay mechanism in the height control valve prevents the transfer of air when the lever is moving during normal ride motions.

GAS-FILLED SHOCK ABSORBERS

Gas-filled shocks absorbers are the new concept in riding stability and driving pleasure. These are automatically adjusting, double-action shock absorbers.

The basic secret in its construction is the combination of highly pressurized N₂ and an all-weather fluid which helps minimize bounce and sway to deliver more comfortable rides. Less bounce and sway improves steering and cornering. In addition, top road contact means less wear on parts and tyres. These features magnify in importance for vehicles with radial tyres or those driven extensively, for sports car and performance buffs. This is truly a remarkable shock absorber that fits most vehicles.

Construction Features. Main constructional features are as follows.

1. Breakage is reduced by seamless eye ring mountings.
2. Oil leakage is reduced by self-sealing packing.

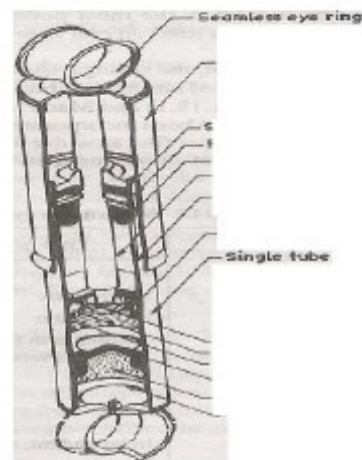

3. Rubber cushion protects shock inside on extreme extension strokes.
4. Hard chromed piston rod reduces wear, minimizes friction.
5. Constant performance from wear resistant piston ring.
6. Large diameter seamless steel cylinder resist splitting.
7. Single tube design reduces heat build-up.
8. Both the extension and compression valves are located in piston for quick response to the forces in either direction.

INDEPENDENT SUSPENSION SYSTEM

Another early form of front independent suspension is called the **trailing link suspension**. This suspension design uses a set of arms located ahead of the wheels to support the unsprung mass. In essence the wheel "trails" the suspension links. Hence the name. Since independent front suspensions were pioneered in production cars to improve the ride characteristics of vehicles as well as minimize the space needed for the suspension itself, early designs like the trailing link suspension attempted to excel in those areas of improvement. Trailing link systems like the one in the front of the old beetle were a success from the manufacturer standpoint as they did improve ride and reduce the packaging size of the suspension. However, there were

Going in chronological order, the first mass produced front suspension design was the **solid beam axle**. Just as it sounds, in the beam axle setup both of the front wheels are connected to each other by a solid axle. This style was carried over to the first automobiles from the horse drawn carriages of the past and worked well enough so that initially no other suspension even needed to be considered. In fact the beam axle can still be found today. New developments in springs, roll bars, and shocks have kept the solid axle practical for some applications. Have you ever taken a look at the front end of a semi or heavy duty truck? If you have, you would've noticed that both of the front wheels are connect by a solid axle. We'll make a quick list of the advantages versus the disadvantages for the beam axle front suspension to help understand why it can be used on heavy trucks but is far from desirable on a performance or passenger car.

After designers had come to realize the severe drawbacks of the solid axle front suspension, they moved on to early attempts at an independent style of front suspension. One of these attempts came to be known as a **swing axle** suspension. It is, as the name suggests, set up so that the axles pivot about a location somewhere near the center of the car and allow the wheels to travel up and down through their respective arcs. This system was eventually adapted for rear suspensions as can be found on the old beetles. I'll use a simple chart to help identify the advantages the swing axle has over the solid axle and highlight some of the shortcomings of this suspension design as well.

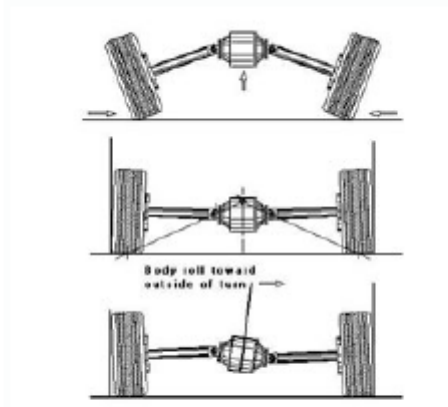

In the 70's the **MacPherson** front suspension assembly became a very popular design on front wheel drive cars. This strut based system, where the spring/shock directly connects the steering knuckle to the chassis and acts as a link in the suspension, offers a simple and compact

suspension package. This is perfect for small front wheel drive cars where space is tight and even allows room for the drive shaft to pass through the knuckle. Today most small cars will use this type of suspension because it is cheap, has good ride qualities, and has the compact dimensions necessary for front wheel drive cars. As with the trailing link style independent suspension, while the MacPherson assembly works very well for production road going cars, on performance cars it is less than ideal. The chart below illustrates this point.

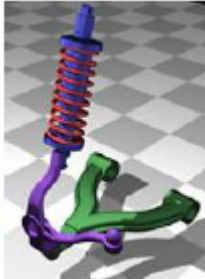

The next evolution in suspension design was to move towards the equal length A-arm setup. This is commonly referred to as a “double wishbone” suspension as the A shaped control arms resemble a wishbone. In this design the suspension is supported by a triangulated A-arm at the top and bottom of the knuckle. The earliest designs of the A-arm suspension included equal length upper and lower arms mounted parallel to the ground. This design has many advantages over any of the previous independent front suspensions. The chart below covers these and details the shortcomings of the first generation of double A-arm designs.

After designing, implementing, and experimenting with the equal length double A-arm suspension it was very apparent that all that was needed to make the double A-arm front suspension satisfactory for high performance use was to determine a way for the suspension to gain negative camber as it was compressed. (I.e. during chassis roll) The problem was solved by implementing upper and lower A-arms of different length. The resulting unequal length double A-arm suspension was born.

ELECTRICAL SYSTEM

A starter is an electric motor, pneumatic motor, hydraulic motor, or other device for rotating an internal-combustion engine so as to initiate the engine's operation under its own power.

Engines are feedback systems which once started, rely on the motion from each nth cycle to initiate the next cycle. In a four-stroke engine, the third stroke releases energy from the fuel, powering the fourth (exhaust) stroke and also the first two (intake, compression) strokes of the next cycle, as well as powering the engine's external load. To get this feedback started, the first two strokes must be powered in some other way. The starter motor is used for this purpose, and then is not needed once the feedback system is running.

The electric starter motor or starting motor is the most common type used on gasoline engines and small Diesel engines. The modern starter motor is either a permanent-magnet or a series-parallel wound direct current electric motor with a starter solenoid (similar to a relay) mounted on it. When current from the starting battery is applied to the solenoid, usually through a key-operated switch, the solenoid engages a lever that pushes out the drive pinion on the starter driveshaft and meshes the pinion with the starter ring gear on the flywheel of the engine.

The solenoid also closes high-current contacts for the starter motor, which begins to turn. Once the engine starts, the key-operated switch is opened; a spring in the solenoid assembly pulls the pinion gear away from the ring gear, and the starter motor stops. The starter's pinion is clutched to its drive shaft through an overrunning sprag clutch which permits the pinion to transmit drive in only one direction. In this manner, drive is transmitted through the pinion to the flywheel ring gear, but if the pinion remains engaged (as for example because the operator fails to release the key as soon as the engine starts, or if there is a short and the solenoid remains engaged), the pinion will spin independently of its drive shaft. This prevents the engine driving the starter, for such back drive would cause the starter to spin so fast as to fly apart. However, this sprag clutch arrangement would preclude the use of the starter as a generator if employed in hybrid scheme mentioned above, unless modifications were made. Also, a standard starter motor is only designed for intermittent use which would preclude its use as a generator; the electrical components are designed only to operate for typically under 30 seconds before overheating (by too-slow dissipation of heat from ohmic losses), to save weight and cost. This is the same reason why most automobile owner's manuals instruct the operator to pause for at least ten seconds after each ten or fifteen seconds of cranking the engine, when trying to start an engine that does not start immediately.

Our experiments have consistently shown that homemade PM alternators are the most powerful and cost-effective solution for building a wind generator. Their low-rpm performance is excellent, and at high speeds they can really crank out the amps thanks to their efficiency. Our more recent PM alternators have been based on Volvo disc brake assemblies, which are very sturdy and have thrust bearings built into the unit. Our larger units are "Disc" or "Axial" designs...a flat plate of magnets rotating next to a flat plate of coils. Our smaller PM alternators are "Radial" designs, where the magnets are fastened to the outside radius of the armature. Since all alternators produce AC, the output must be converted to DC with bridge rectifiers for battery charging.

Our designs to date have been single phase for ease of construction. Three-phase alternators have some advantages (they are somewhat more efficient, and make better use of available space), but they are somewhat more difficult to build.

With a 7 ft diameter prop, our Volvo brake designs can put more than 60 amps into a 12 volt battery in a 30-mph breeze--that's about 700 watts. We've seen the Volvo design peak at over 100 amps during high winds! This gives these homebrew designs a big advantage over similar-sized converted induction motors, which become inefficient quickly and top out at 20-25 amps output with a 7 ft. diameter prop.

Induction Motor Conversion Alternators

- Advantages: cheap, easy to find, fairly easy to convert, good low-rpm performance.

DC Generators

- **Advantages:** Simple and pre-assembled, some are good at low rpm.
- **Disadvantages:** High maintenance, most are not good at low rpm, large sizes very hard to find, small ones have limited power output.
- **Suitability for Wind Power:** POOR to OK

Brushless DC PM Servo Motors

A brushless DC permanent magnet motor is really just a permanent magnet alternator! A special driver circuit provides AC power that is in phase with the rotation. If you are able to find a large one of these surplus, it's possible you might have an excellent start for a wind power project. They are used in robotics and precision control applications, and some use Nd-Fe-B magnets for high torque in a small space.

Induction Motors as Alternators

It's possible to make a 3-phase induction motor produce electricity, either 3-phase or single phase. This requires a controller and capacitor. The generator must run at a fairly constant speed. For this reason, this type of generator is more suitable for constant-speed hydro power installations than for wind, where speed varies--though it can be done. We have not experimented with this technique yet, since we don't have a suitable hydropower source. For more information, check out the book *Motors as Generators for Micro-Hydro Power* by Nigel Smith

Cut-Out Relay at High/Low RPMs

When the armature in the generator is spinning fast enough (about 1000 generator RPM or 750 engine RPM), the current in the shunt windings (3g) of the cut-out relay will generate a magnetic field strong enough to overcome the natural spring tension of the contact arm (3d). It snaps own, bringing the two contacts together. Current now flows through the series windings (3e), across the contacts and out the arm (3d), finally reaching the output terminal (usually "A") on the control box. From there, it goes on to the ammeter (if fitted) and then to the battery.

This current now flowing through the series windings (3e) actually intensifies the magnetic field around the core (3f) of the cut-out relay, and this in turn holds the arm down even more firmly, pressing the contacts (3d) together. The point when the contacts close is usually adjusted so that the internal voltage of the regulator is about 12.7 to 13 volts. When the engine slows to idle, the armature slows down as well. This means that the voltage induced in the spinning armature drops. Lower voltage reduces the strength of the magnetic field holding the series winding's contacts (3d) closed. Eventually, the weakened magnetic field can no longer hold against the

MAGNETO IGNITION SYSTEM

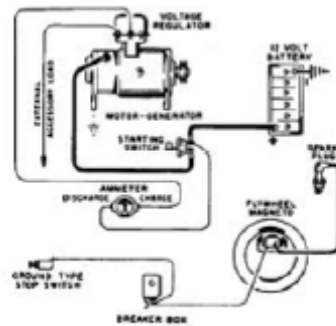

In magneto ignition system a magneto is used to generate electric current for producing spark. A high tension magneto generates a very high voltage needed for spark plug

Main components of magneto ignition system

- a) Frame
- b) Permanent magnet
- c) Armature
- d) Soft iron field
- e) rotor
- f) Primary and secondary winding
- g) Breaker points
- h) Condenser

The armature consists of an iron core on which there are two sets of windings

- 1) Primary
- 2) Secondary

The armature is driven by the engine. As the armature rotates, primary windings cut the lines of force of magnetic field and an induced current flows in the primary circuit. As the primary current reaches its maximum value in each direction, the primary circuit is suddenly opened by a contact breaker and the current collapses. This action induces a very high voltage in the secondary winding which causes a momentary spark to jump at the spark plug gap. A distributor is provided which carries current to the spark plug through high tension wires. The condenser is used to eliminate the arching at the breaker points and intensifying the current in the secondary circuit. For multi cylinder engines, a distributor and a rotor are required to distribute the current to different spark plugs.

Electronic ignition

The disadvantage of the mechanical system is the use of breaker points to interrupt the low-voltage high-current through the primary winding of the coil; the points are subject to mechanical wear where they ride the cam to open and shut, as well as oxidation and burning at the contact surfaces from the constant sparking. They require regular adjustment to compensate for wear, and the opening of the contact breakers, which is responsible for spark timing, is subject to mechanical variations.

In addition, the spark voltage is also dependent on contact effectiveness, and poor sparking can lead to lower engine efficiency. A mechanical contact breaker system cannot control an average ignition current of more than about 3 A while still giving a reasonable service life, and this may limit the power of the spark and ultimate engine speed.

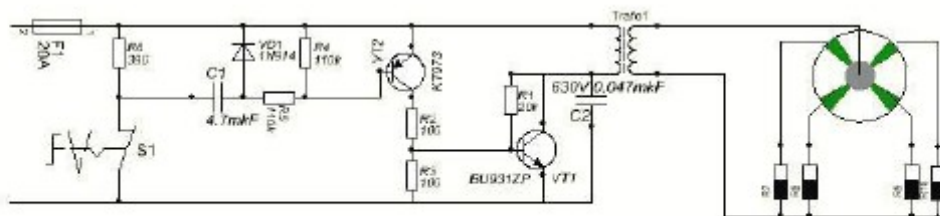

Sealed Lead Acid

The first sealed, or maintenance-free, lead acid emerged in the mid-1970s. The engineers argued that the term "sealed lead acid" is a misnomer because no lead acid battery can be totally sealed. This is true and battery designers added a valve to control venting of gases during stressful charge and rapid discharge. Rather than submerging the plates in a liquid, the electrolyte is impregnated into a moistened separator, a design that resembles nickel- and lithium-based systems. This enables to operate the battery in any physical orientation without leakage.

The sealed battery contains less electrolyte than the flooded type, hence the term "acid-starved." Perhaps the most significant advantage of the sealed lead acid is the ability to combine oxygen and hydrogen to create water and prevent water loss. The recombination occurs at a moderate pressure of 0.14 bar (2psi). The valve serves as safety vent if gases buildup during over-charge or stressful discharge. Repeated venting would lead to an eventual dry out.

Driven by these advantages, several types of sealed lead acid have emerged and the most common are *gel*, also known as *valve-regulated lead acid* (VRLA), and *absorbent glass mat* (AGM). The gel cell contains a silica type gel that suspends the electrolyte in a paste. Smaller packs with capacities of up to 30Ah are called SLA (sealed lead acid). Packaged in a plastic container, these batteries are used for small UPS, emergency lighting, ventilators for healthcare and wheelchairs. Because of economical price, dependable service and low maintenance, the SLA remains the preferred choice for biomedical and healthcare in hospitals and retirement homes. The VRLA is the larger gel variant used as power backup for cellular repeater towers, Internet hubs, banks, hospitals, airports and other sites.

The AGM is a newer design and suspends the electrolyte in a specially designed glass mat. This offers several advantages to lead acid systems, including faster charging and instant high load currents on demand. AGM works best as a mid-range battery with capacities of 30 to 100Ah and is less suited for large systems, such as UPS. Typical uses are starter battery for motorcycles, start-stop function for micro-hybrid cars, as well as marine and RV that need some cycling.

With cycling and age, the capacity of AGM fades gradually; gel, on the other hand, has a dome shaped performance curve and stays in the high performance range longer but then drops suddenly towards the end of life. AGM is more expensive than flooded, but is cheaper than gel. (Gel would be too expensive for start/stop use in cars.)

Unlike the flooded, the sealed lead acid battery is designed with a low over-voltage potential to prohibit the battery from reaching its gas-generating potential during charge. Excess charging causes gassing, venting and subsequent water depletion and dry out. Consequently, gel, and in part also AGM, cannot be charged to their full potential and the charge voltage limit must be set lower than that of a flooded. The float charge on full charge must also be lowered. In respect to charging, the gel and AGM are no direct replacements to the flooded type. If no designated charger is available with lower voltage settings, disconnect the charger after 24 hours of charge. This prevents gassing due to a float voltage that is set too high.

Charging system used in an automobile

Automotive vehicles include a storage battery for operating electronics in the vehicle and using an electric starter to start the vehicle engine. Automotive batteries provide power for the vehicle's starting, lighting and ignition (SLI) components of the car. The rechargeable battery provides cranking power to start the vehicle and also is the only source of power to continue to maintain the lights or other devices in operation when the vehicle ignition has been turned off. When the vehicle is running, the engine is used to charge the battery. Additionally, the battery is also used to power electrical components of the vehicle when the engine is running. Automotive battery terminals typically comprise a conical contact section for mounting to a conical battery post terminal, and having a clamping mechanism for tightening the contact section to the battery terminal, the terminal further comprising a conductor connection section. A battery charging system is coupled to the engine and is powered by the engine when the vehicle is running. The charging system is used to charge the storage battery when the vehicle is operating. Typical charging systems include a simple voltage regulator connected to the output of an alternator. The voltage regulator is used to set a voltage generated by the alternator which is applied to the battery. Voltage regulator controlled car battery charging systems keep an automotive storage battery at full charge level and to provide sufficient electrical power for the operation of the various automobile electrical accessories.

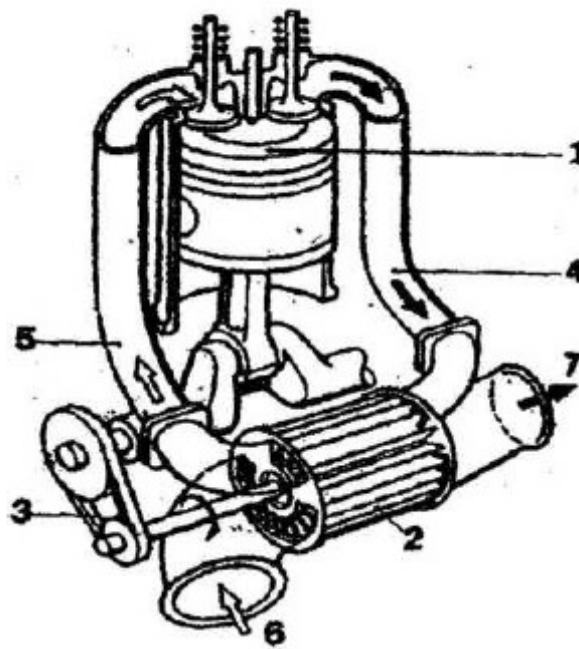

Translation Auto Care Center is the leader in Missoula for the service and repair of auto charging systems. Our Missoula auto shop staff takes the time to educate our customers in knowing that the battery, starting and charging systems in their car or truck play pivotal roles in ensuring the dependable operation of your vehicle while driving in and around Missoula. The car battery stores electrical energy that is then converted by the starter into the mechanical force necessary to start your engine. The alternator then serves the purpose of producing the electrical current-initially provided by the car battery-that is necessary for the vehicle's electrical needs when the engine is running. The ignition module turns the low voltage supply to the ignition coil on and off, which in turn is converted to a higher voltage that is necessary for the vehicle's ignition system to operate. The voltage is used to engage the spark plugs and create the sparks that are necessary to ignite the combined air/fuel mixture in the car engines cylinders. It is this ignition that is ultimately used to power the pistons that in turn begin the rest of the process of powering your car or truck.

There are various factors that contribute to the wear and tear of your vehicle's battery, charging and starting systems. For example the frequent turning on and off of your automobile when running errands in Missoula will cause more wear and tear than a daily commute to and from your Missoula workplace. Other factors that affect the wear and tear of the battery, charging, and starting system include Missoula driving and weather conditions, overall mileage, vehicle age,

and various automotive components like in vehicle entertainment systems that cause an excessive electrical draw.

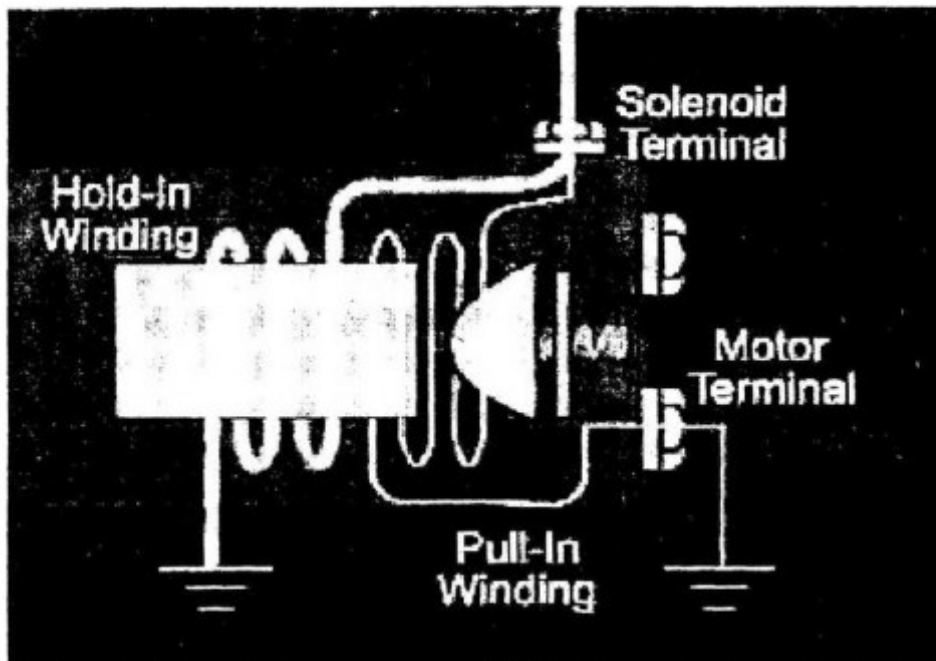

The symptoms you may experience that indicate possible problems with your battery, charging, and starting systems include the dimming of headlights and interior lights, the "check engine" and/or battery light coming on, or the failure of various car or truck accessories.

The mechanics at our Missoula auto repair shop are expertly trained in the complete service and repair of car and truck batteries, charging, and starting systems. If you think you are having problems with any of the components of your charging and starting system bring your car or truck to our Missoula automotive repair service center and let us.

INSTRUMENTS AND THEIR FUNCTIONS

The list of dashboard instruments is too long. Most of them have been enumerated below with their functions given in brief, and details of few of them are given in continuing articles.

Speedometer. It shows instant speed of the vehicle in kilometer per hour (km/ph) throughout its running.

Odometer. It records the distance traveled by the vehicle in kilometer ever since the vehicle is in operation.

Tachometer. It shows the engine speed in r.p.m. It is provided with a RED zone mark, which implies that the engine operation in this speed range may cause serious damage to it.

Ammeter. It is used to indicate the charging current generated by the dynamo and the discharging current from the battery. Automobile ammeters are usually of centre zero style in which right side of scale shows charging current and the left side depicts discharging current. They are available in different range of scales, the most common being 30 amperes on each side with respect to zero in the centre.

Trip Computer. It displays several information such as

- Average speed of the vehicle since the computer was reset.
- Average fuel consumption in litres/100 km since the computer was reset.
- Total running time of the vehicle since the computer was reset.
- Distance traveled from start of a particular trip since the computer was reset total quantity of fuel consumed computer was reset.
- The distance after which the fuel tank will be empty.
- The time of arrival at a particular destination of the journey.
- Overspending of the vehicle than the preset speed given by the speedometer, odometer, and tachometer.

Besides these, there are many other auxiliary information modes. The computer can be reset for any quantity as and when desired. These auxiliary modes are as follows.

In-car temperature sensor. It senses the temperature inside the car compartment and accordingly sets the heater/cooler, or air-conditioning system automatically.

Fuel sensor. It keeps vigil on fuel quantity and informs it through a gauge.

Sunlight sensor. It senses the intensity of sunlight and informs to the temperature sensor inside the car. Accordingly the heater, cooler, or A/C will set-on.

Pressure sensor. It senses the pressure of oil in lubrication system and informs to the gauge for display. Temperature gauge. It indicates the temperature of engine cooling water when the ignition is switched ON. Lubricating oil pressure gauge. It displays the oil pressure. If the pressure is lower than the stipulated value, a red bulb indication appears on dashboard.

Fuel level gauge. The fuel gauge shows the level of fuel in the fuel tank when the ignition is switched ON. It shows E for empty and F for full at the two extremes.

Text books:

1. Automobile Engg. By R.K. Rajput, S.Chand
2. Automobile Engg. By K.M.Gupta.I, Vol.I & II, Umesh Pub.
3. Automobile Mechanics (through problem) by Dr.N.K. Giri, Khanna Pub.

References

1. The motor vehicle by Newton & Steed, London Liffie Books Ltd.
2. NPTEL Lecture notes
3. Lecture notes by Asso Prof R.K.Maurya (ME Department,AKGEC,GZB)